

Eswarn SCIENTIFIC & CO.

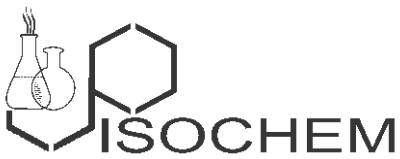

No.205, TN Govt, Employees Society Colony, RMS Colony,
Karumandapam, Trichy - 620 001
Email : eswarrscientific@gmail.com www.eswarrscientific.com

Authorised Distributor



GeNei™

P'fact

Labware & Consumables



Dealers in

Merck, Loba, Qualigens, Rankem, Avra,

Himedia, Sigma Aldrich, Alfa Aesar,

Whatman, Borosil, Tarson, Shimadzu, Systronics

INDEX

A

Alkoxy Group Determination	
Apparatus	71
Acetyl Group Determination	
Apparatus	71

Adapters

Reduction	1
Expansion	1
T connection	2
Multiple	2
Cone	3
Socket	3
Receiver	4

Adapters Connecters

Claisen Head	5
Recovery Bend	6
Still Head Plain	6
Splash head	7
Ammonia Distillation	74

B

Beakers	9
---------	---

Bottles

Dropping	10
Gas Wash	11
Reagent	10
Specific Gravity	12
BOD Bottle	12
Wash	11
Weighing	9

Burette

Automatic	14
Glass Stopcock	13
Screw (Teflon) Stopcock	13
Overflow Cup	14

C

Centrifuge vessels	50
Chromatography columns	21
Chromatography spray	20
Climbing film evaporator	72

Condensers

Air	17
Allihn (Bulb)	19
Coil	18
Double Surface	19
Immersion	19
Jacketed Coil	18
Liebig	17
Thrope	18
Vertical Distillate	18

Circulatory Cyclone Evaporator	72
--------------------------------	----

Crow Receivers	23
----------------	----

Cylinders

Measuring	22
Nessler	23

D

Desiccators	23
-------------	----

Dean & Stark apparatus	73
------------------------	----

Destructive distillation assembly	67
-----------------------------------	----

Dilatometer	52
-------------	----

Distillation assemblies	59
-------------------------	----

Dish Petri	23
------------	----

Dropper	46
---------	----

Distillation Unit	70
-------------------	----

INDEX

E

Essential oil determination apparatus (Clevenger's)	77,78
Extractor	79

F

Filter pump	35
-------------	----

Flasks

Conical	30
Conical Stopped	31
Filter	31
Flat bottom Plain	25
Flat Bottom Single Neck	29
Iodine	31
Kjeldahl	32
Kohlrausch	34
Micro-Round bottom	25
Pearshaped	33
Phenol	34
Round Bottom Plain	25
Round Bottom Single Neck	26
Round Bottom Two Neck	27
Round Bottom Three Neck	28
Saybolt	34
Saybolt Viscosity	34
Volumetric (Standard)	32
Fractionating Columns	20
Fractionating Assemblies	64
Frothy Liquids Distillation Assembly	67

Funnel

Filter	35
Powder	35
Pressure Equalizing	40
Separating	36
Separating Spherical	37
Separating Conical	38

G

Gas Absorption Assembly	67
Gas Evaluation Assemblies	65
Gooch Crucible	24
Gooch Crucible adapter	24
Gas Analysis (Orsat) Apparatus	80
Gas Burette	82

K

Kjeldahl Distillation Assemblies	63
Kuderna Danish Evaporator	71

L

Lands Burger Boiling Apparatus	73
--------------------------------	----

M

Markham Semi Micro Distillation	75
Mercury Distillation Assembly	74
Membrane Filter Holder Assembly	75

N**NABL CERTIFIED GLASSWARES**

Burette A Class	85
Burette Amber A Class	85
Measuring Cylinder A Class	85
Pipette Volumetric A Class	86
Pipette Graduated A Class	86
Volumetric (Standard) A Class	87
Volumetric (Standard) Amber A Class	87

O

Orsat Apparatus	80, 81
Ostwald viscometer	53

P

Parnas and Wagner apparatus	76
Pipettes	
Automatic	42
Blow-out	44
Drain-out	43
Graduated	43
Volumetric	41
Preparation assembly	60
Pyknometers	52

R

Reaction assemblies	57,58
Recovery assemblies	68
Re-distillation assemblies	74
Reflux assembly	54-56

S

Solvent recovery assembly	68,69
Soxhlet extraction apparatus	79
Spray for Chromatography	20
Steam Distillation Assemblies	65,66
Stirrers	45
Stirrer Guide	46
Stopcocks	15
Stoppers	16

T

Thermometer pocket	8
--------------------	---

Tubes

Blood sugar	51
Calcium chloride	50
Centrifuge	49
Connection	51
Culture	52
Drying	5
Melting Point	48
Test Tube Plain	47
Test Tube Stoppered	48
Test Tube Graduated	48
T & U & Y Shape	51

V

Viscometers College pattern	53
Volatile acid determination	77
Vacuum Distillation Assembly	61,62
Vacuum Sublimation Assembly	67

W

Water Estimation Apparatus	73
Water Still Single Distillation Unit	83
Water Still Double Distillation Unit	84

Adapters
Reduction, Expansion

Eswarr



A - 1

A - 1 Reduction Adapters, *Eswarr*

Cat. No.	Socket	Cone	Price
ES 0002	14/23	24/29	285.00
ES 0004	14/23	29/32	325.00
ES 0006	19/26	24/29	345.00
ES 0008	19/26	29/32	345.00
ES 0010	19/26	34/35	425.00
ES 0012	19/26	45/40	460.00
ES 0014	19/26	55/44	475.00
ES 0016	24/29	29/32	390.00
ES 0018	24/29	34/35	465.00
ES 0020	24/29	45/40	465.00
ES 0022	29/32	55/44	790.00
ES 0024	29/32	34/35	475.00
ES 0026	29/32	45/40	515.00
ES 0028	29/32	55/44	810.00



A - 2

A - 2 Expansion Adapters, *Eswarr*

Cat. No.	Socket	Cone	Price
ES 0030	19/26	14/23	255.00
ES 0032	24/29	19/26	285.00
ES 0034	24/29	14/23	285.00
ES 0036	29/32	24/29	390.00
ES 0038	29/32	19/26	390.00
ES 0040	29/32	14/23	370.00
ES 0042	34/35	29/32	490.00
ES 0044	34/35	24/29	490.00
ES 0046	34/35	19/26	490.00

A - 3 Multiple Adapters, Two Necks Parallel, *Eswarr*

Cat. No.	Socket	Cone	Price
ES 0048	10/19	10/13	265.00
ES 0050	14/23	14/23	340.00
ES 0052	19/26	19/26	390.00
ES 0054	19/26	24/29	390.00
ES 0056	19/26	34/35	410.00
ES 0058	24/29	24/29	440.00
ES 0060	29/32	29/32	590.00

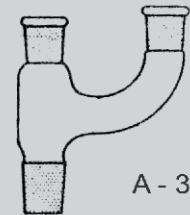

A - 3

A - 4 Multiple Adapters, Two Necks, One Vertical and One at Angle, *Eswarr*

Cat. No.	Socket	Cone	Price
ES 0062	19/26	19/26	390.00
ES 0064	19/26	24/29	390.00

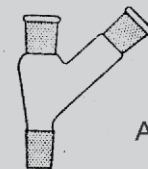

A - 4

A - 5 Multiple Adapters, Three Necks, Two Parallel and One at Angle, *Eswarr*

Cat. No.	Parallel Neck Socket	Angle Neck Socket	Cone	Price
ES 0066	14/23	14/23	19/26	590.00
ES 0068	19/26	14/23	24/29	610.00
ES 0070	19/26	19/26	24/29	610.00
ES 0072	19/26	19/26	29/32	650.00

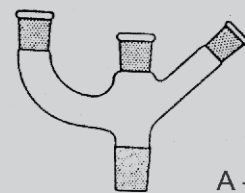

A - 5

A - 6 Adapters With 'T' Connection, *Eswarr*

Cat. No.	Socket	Cone	Price
ES 0074	14/23	14/23	260.00
ES 0076	14/23	19/26	260.00
ES 0078	14/23	24/29	310.00
ES 0080	19/26	19/26	310.00
ES 0082	19/26	24/29	360.00

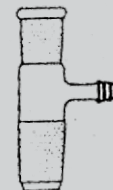

A - 6

Adapters
Cone, Socket

Eswarr

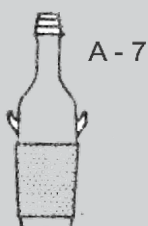

A - 7 Cone Adapters, Straight Connection Plain, *Eswarr*

Cat. No.	Cone	Price
ES 0084	10/19	125.00
ES 0086	14/23	141.00
ES 0088	19/26	175.00
ES 0090	24/29	210.00
ES 0092	29/32	225.00
ES 0094	34/35	290.00

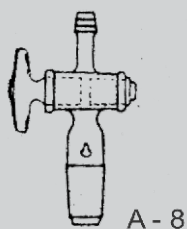

A - 8 Cone Adapters, Straight Connection with Stopcock, *Eswarr*

Cat. No.	Cone	Price
ES 0096	14/23	430.00
ES 0098	19/26	460.00
ES 0100	24/29	475.00
ES 0102	29/32	513.00

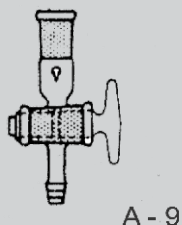

A - 9 Socket Adapters, Straight Connection with Stopcock, *Eswarr*

Cat. No.	Cone	Price
ES 0104	14/23	430.00
ES 0106	19/26	460.00
ES 0108	24/29	475.00
ES 0110	29/32	513.00

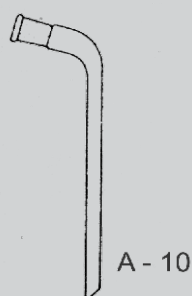

A - 10 Receiver Adapters, Plain Bend, Long, *Eswarr*

Cat. No.	Cone	Price
ES 0112	10/19	155.00
ES 0114	14/23	155.00
ES 0116	19/26	185.00
ES 0118	24/29	195.00
ES 0120	29/32	290.00
ES 0122	34/35	290.00

A - 11 Receiver Adapters, Straight Delivery, *Eswarr*

Cat. No.	Socket	Price
ES 0124	14/23	160.00
ES 0126	19/26	175.00
ES 0128	24/29	210.00
ES 0130	29/32	230.00
ES 0132	34/35	285.00
ES 0134	45/40	361.00

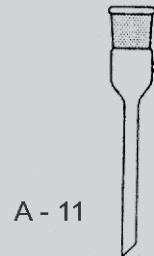

A - 11

A - 12 Receiver Adapters, Plain Bend, Socket to Cone, *Eswarr*

Cat. No.	Socket	Cone	Price
ES 0136	14/23	14/23	240.00
ES 0138	19/26	19/26	260.00
ES 0140	19/26	24/29	260.00
ES 0142	24/29	24/29	345.00
ES 0144	29/32	29/32	513.00
ES 0146	34/35	34/35	833.00

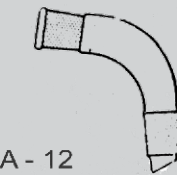

A - 12

A - 13 Receiver Adapters, Bent with Vent, *Eswarr*

Cat. No.	Socket	Cone	Price
ES 0148	10/19	10/13	210.00
ES 0150	14/23	14/23	230.00
ES 0152	19/26	19/26	290.00
ES 0154	19/26	24/29	360.00
ES 0156	24/29	24/29	303.00
ES 0158	29/32	29/32	540.00

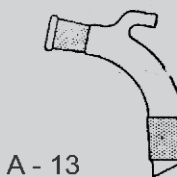

A - 13

A - 14 Receiver Adapters, Vertical with Vacuum Connection, *Eswarr*

Cat. No.	Socket	Cone	Price
ES 0160	19/26	24/29	303.00
ES 0162	24/29	24/29	334.00

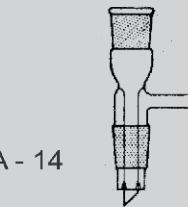

A - 14

Adapters Receiving

Eswarr

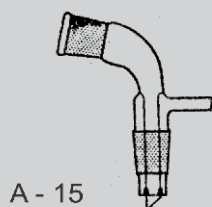

A - 15

A - 15 Receiver Adapters, Bent with Vacuum Connection, *Eswarr*

Cat. No.	Socket	Cone	Price
ES 0164	14/23	14/23	390.00
ES 0166	14/23	19/26	410.00
ES 0168	19/26	19/26	410.00
ES 0170	19/26	24/29	490.00
ES 0172	24/29	24/29	490.00

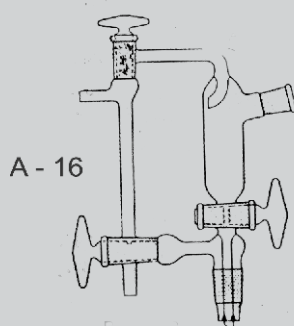

A - 16

A - 16 Intermediate Receiver Adapters (PERKIN) *Eswarr*

Cat. No.	Socket	Cone	Cap. ml	Price
ES 0174	14/23	14/23	10	1910.00
ES 0176	19/26	19/26	32	2290.00
ES 0178	19/26	24/29	32	2290.00
ES 0180	24/29	24/29	32	2290.00

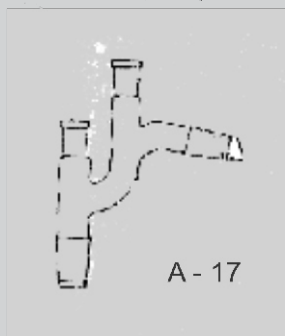

A - 17

A - 17 Claisen Heads, Sloping, *Eswarr*

Cat. No.	Flask Cone	Cond. Cone	Socket	Price
ES 0216	19/26	19/26	14/23	490.00
ES 0218	24/29	19/26	14/23	490.00
ES 0220	24/29	24/29	14/23	590.00
ES 0222	29/32	29/32	14/23	650.00

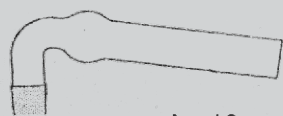

A - 18

A - 18 Drying Tubes, Angled, *Eswarr*

Cat. No.	Cone	Price
ES 0224	14/23	165.00
ES 0226	19/26	185.00
ES 0228	24/29	205.00
ES 0230	29/32	265.00

Eswarr

Adapters
Connecting

A - 19 Recovery Bend, Sloping, *Eswarr*

Cat. No.	Flask Cone	Cond. Cone	Price
ES 0232	19/26	19/26	265.00
ES 0234	24/29	14/23	276.00
ES 0236	24/29	19/26	276.00
ES 0238	24/29	24/29	276.00
ES 0240	29/32	19/26	369.00
ES 0242	29/32	29/32	369.00



A - 19

A - 20 Recovery Bend, Vertical, *Eswarr*

Cat. No.	Flask Cone	Cond. Cone	Price
ES 0244	14/23	14/23	260.00
ES 0246	19/26	19/26	336.00
ES 0248	24/29	19/26	433.00
ES 0250	24/29	24/29	433.00

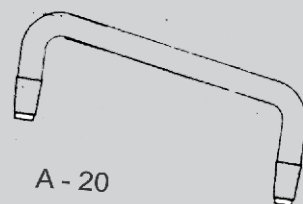

A - 20

A - 21 Plain Stillheads, Sloping, *Eswarr*

Cat. No.	Flask Cone	Cond. Cone	Socket	Price
ES 0252	14/23	14/23	14/23	375.00
ES 0254	19/26	19/26	14/23	410.00
ES 0256	19/26	19/26	19/26	475.00
ES 0258	24/29	19/26	14/23	490.00
ES 0260	24/29	24/29	14/23	520.00
ES 0262	29/32	19/26	14/23	520.00
ES 0264	29/32	29/32	14/23	790.00

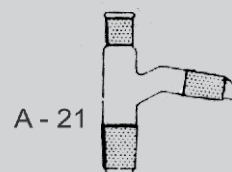

A - 21

Adapters Connecting

Eswarr



A - 22

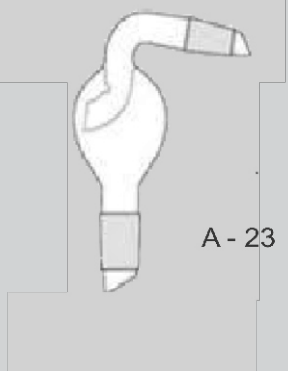

A - 23

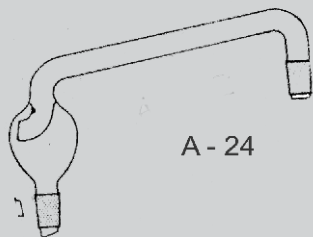

A - 24

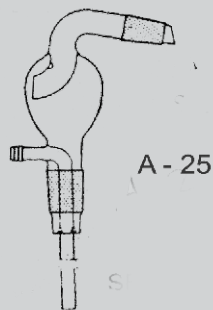

A - 25

A - 22 Splash Head Adapters, *Eswarr*

Cat. No.	Socket	Cone	Price
ES 0266	19/26	24/29	475.00
ES 0268	24/29	24/29	545.00

A - 23 Splash Heads, Sloping, *Eswarr*

Cat. No.	Flask Cone	Cond. Cone	Price
ES 0270	24/29	19/26	540.00
ES 0272	24/29	24/29	590.00
ES 0274	29/32	19/26	540.00
ES 0276	29/32	29/32	630.00
ES 0278	34/35	19/26	610.00

A - 24 Splash Heads, Vertical, *Eswarr*

Cat. No.	Flask Cone	Cond. Cone	Price
ES 0280	19/26	19/26	540.00
ES 0282	24/29	19/26	570.00
ES 0284	24/29	24/29	710.00

A - 25 Steam Distillation Heads, Sloping, *Eswarr*

Cat. No.	Socket	Cone	Price
ES 0286	24/29	19/26	770.00
ES 0288	34/35	19/26	940.00

A - 26 Thermometer Pocket, Closed end, *Eswarr*

Cat. No.	Cone	Stem length mm	Price
ES 0290	14/23	42	175.00

A - 27 Thermometer Pockets, Open end for Closing, *Eswarr*

Cat. No.	Cone	Stem length mm	Price
ES 0292	14/23	200	190.00
ES 0294	14/23	400	220.00
ES 0296	19/26	200	210.00
ES 0298	19/26	400	220.00

A - 28 AIR/Steam Inlet Tubes, Straight, *Eswarr*

Cat. No.	Cone	Stem length mm	Price
ES 0300	7/16	100	140.00
ES 0302	10/19	100	132.00
ES 0304	14/23	150	132.00
ES 0306	19/26	150	140.00
ES 0308	24/29	150	210.00
ES 0310	29/32	150	210.00

A - 29 AIR/Steam Inlet Tubes, Bent, *Eswarr*

Cat. No.	Cone	Stem length mm	Price
ES 0312	10/19	100	160.00
ES 0314	14/23	150	170.00
ES 0316	19/26	150	190.00
ES 0318	24/29	150	215.00

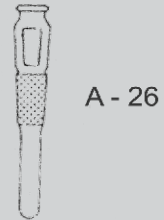

A - 26



A - 27



A - 28



A - 29

Beakers,
Weighing Bottles

Eswarr



B - 1

B - 1 Beaker Low Form with Spout *Eswarr*

Cat. No.	Cap. ml	Price
ES 3032	10	110.00
ES 3033	25	110.00
ES 3034	50	66.00
ES 3035	100	77.00
ES 3036	150	77.00
ES 3037	250	85.00
ES 3244	400	135.00
ES 3038	500	130.00
ES 3245	600	180.00
ES 3039	1000	280.00
ES 3241	2000	550.00
ES 3242	5000	2090.00



B - 2

B - 2 Weighing Bottles, Tall Form, Common Type, *Eswarr*

Cat. No.	Ht. X Dia. mm	Approx. Cap. ml	Joint size	Price
ES 0344	40x20	5	19/10	260.00
ES 3151	60x25	15	24/10	275.00
ES 3152	65x30	25	29/12	330.00
ES 0350	80x40	60	40/13	690.00



B - 3

B - 3 Weighing Bottles, Squat Form, Common Type, *Eswarr*

Cat. No.	Ht. X Dia. mm	Approx. Cap. ml	Joint size	Price
ES 0352	35x40	20	40/13	290.00
ES 0354	35x50	30	50/14	358.00
ES 0356	35x60	40	55/15	459.00

Eswarr

Bottles Reagent
Dropping,

B - 4 Bottle Reagent with I/C Stopper *Eswarr*

Cat. No.	Cap. MI	Price
ES 3122	60	305.00
ES 3123	125	345.00
ES 3124	250	345.00
ES 3125	500	360.00
ES 3126	1000	570.00
ES 3127	2000	1040.00

B - 4



B - 5 Bottle Reagent with Screw Cap *Eswarr*

Cat. No.	Cap. MI	Price
ES 3201	60	305.00
ES 3202	100	345.00
ES 3203	250	345.00
ES 3204	500	360.00
ES 3205	1000	570.00
ES 0380	2000	1040.00

B - 5

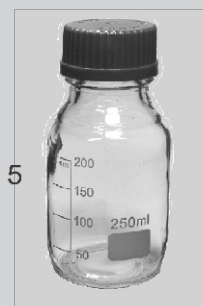

B - 6 Dropping Bottles, with Pipette Filler, *Eswarr*

Cat. No.	Cap. ml	Price
ES 0382	30	255.00
ES 0384	60	345.00
ES 0386	125	365.00

B - 6



Bottles
Gas Wash

Eswarr

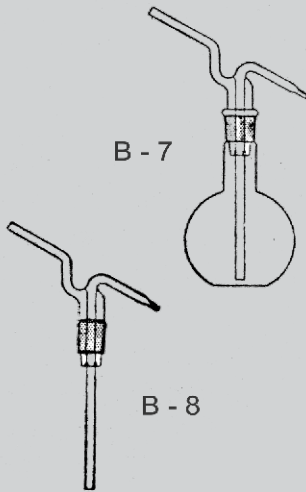

B - 7 Wash Bottles, Complete, *Eswarr*

Cat. No.	Cap.ml	Joint Size	Price
ES 3161	250	24/29	475.00
ES 3162	500	24/29	690.00

B - 8 Wash Bottle Fitting Only, *Eswarr*

Cat. No.	For Cap. MI	Price
ES 0392	250	290.00
ES 0394	500	290.00

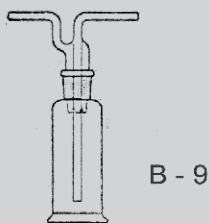

B - 9 Gas Washing Bottles Ordinary Complete (JOINT SIZE 29/32), *Eswarr*

Cat. No.	Cap. MI	Price
ES 0396	125	915.00
ES 0398	250	990.00
ES 0400	500	1150.00

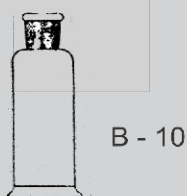

B - 10 Gas Washing Bottles, Bottle Only (JOINT SIZE 29/32), *Eswarr*

Cat. No.	Cap. MI	Price
ES 0402	125	790.00
ES 0404	250	810.00
ES 0406	500	840.00

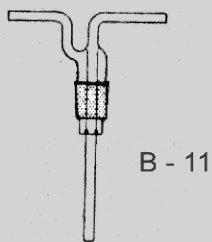

B - 11 Gas Washing Bottles Fitting Only (JOINT SIZE 29/32), *Eswarr*

Cat. No.	For Cap. ml	Price
ES 0408	125	318.00
ES 0410	250	318.00
ES 0412	500	318.00

Eswarr

Bottles
Specific Gravity

B - 12 Specific Gravity Bottles, with Capillary Bore Stopper, *Eswarr*

Cat. No.	Cap.ml	Joint	Price
ES 3142	25	10/15	470.00
ES 3143	50	10/15	510.00
ES 0418	100	10/15	560.00



B - 12

B - 13 Specific Gravity Bottles, with Teflon Stopper, *Eswarr*

Cat. No.	Cap.ml	Joint	Price
ES 0420	25	10/15	985.00
ES 0422	50	10/15	1050.00



B - 13

B - 14 Specific Gravity Bottle, Hubbards, Cylindrical, *Eswarr*

Cat. No.	Cap. MI	Joint	Price
ES 0426	25	24/10	855.00

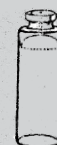

B - 14

B - 15 BOD Bottle, *Eswarr*

Cat. No.	Cap. MI	Price
ES 3111	60	530.00
ES 3112	125	650.00
ES 3113	300	780.00



B - 15

Burette

Eswarr

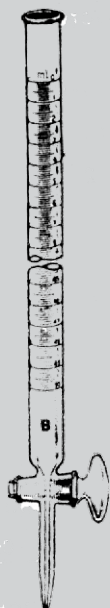

B - 16



B - 17

B - 16 Burettes, Single Bore Glass Stopcock Class B, *Eswarr*

Cat. No.	Cap.ml	Sub-dvn.ml	Tol. +ml	Price
ES 3212	10	0.05	0.05	513.00
ES 3213	25	0.1	0.1	513.00
ES 0432	25	0.05	0.05	513.00
ES 3214	50	0.1	0.1	560.00
ES 3215	100	0.1	0.1	690.00

B - 17 Burettes, Single Bore Screwcock, Class B, *Eswarr*

Cat. No.	Cap.ml	Sub-dvn.ml	Tol.+ml	Price
ES 0438	10	0.1	0.05	430.00
ES 3222	10	0.05	0.05	450.00
ES 3223	25	0.1	0.1	450.00
ES 0444	25	0.05	0.05	460.00
ES 3224	50	0.1	0.1	510.00
ES 3225	100	0.1	0.1	720.00

Eswarr

Burettes Overflow cup
& Automatic

B - 18 Burettes, Overflow Cup, Glass Stopcock, Class B, *Eswarr*

Cat. No.	Cap.ml	Sub-dvn.ml	Tol. +ml	Price
ES 0450	50	0.10	0.2	790.00

B - 18



B - 19 Burettes, Overflow Cup, Glass Stopcock, Class B, *Eswarr*

Cat. No.	Cap.ml	Sub-dvn.ml	Tol.+ml	Price
ES 0452	10	0.05	0.05	2490.00
ES 0452	25	0.1	0.1	2490.00
ES 0454	50	0.1	0.1	2790.00
ES 0456	100	0.2	0.2	2790.00

B - 19



B - 20 Burettes, Automatic with Reservoir, Rubber Blow, Glass Stopcock, Class B, *Eswarr*

Cat. No.	Cap.ml	Sub-dvn.ml	Tol.+ml	Price
ES 0458	10	0.05	0.05	4090.00
ES 0460	25	0.1	0.10	4090.00
ES 0462	50	0.1	0.10	4490.00
ES 0464	100	0.1	0.20	5090.00

B - 20

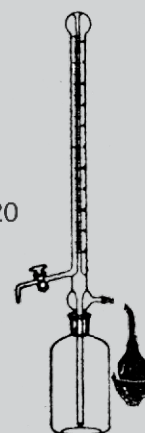

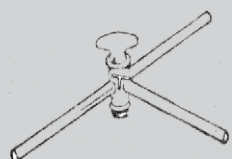

B - 21

S - 21 Stopcocks, 'T' Bore, *Eswarr*

Cat. No.	Bore mm	Arm dia mm	Price
ES 0466	1	7	563.00
ES 0468	2	8	563.00
ES 0470	3	9	563.00
ES 0472	4	10	789.00
ES 0474	6	11	1291.00

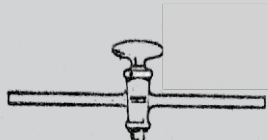

B - 22

S - 22 Stopcocks, Straight Bore, *Eswarr*

Cat. No.	Bore mm	Arm dia mm	Price
ES 0476	2	8	237.00
ES 0478	3	9	237.00
ES 0480	4	10	371.00
ES 0482	6	11	371.00
ES 0484	8	12	541.00

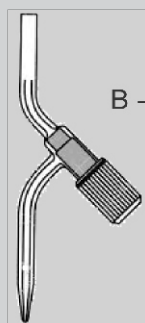

B - 23

S - 23 Screw cock, Plain Bore, Inter-changeable Plunger, *Eswarr*

Cat. No.	Bore mm	Arm dia mm	Size	Price
ES 0486	3	8	GP 13	217.00
ES 0488	6	10	GP 18	491.00

S - 24 Stoppers Solid (B SIZE), *Eswarr*

Cat. No.	Cone	Price
ES 0490	10/19	97.00
ES 0492	12/21	97.00
ES 0494	14/23	97.00
ES 0496	19/26	105.00
ES 0496	24/29	112.00
ES 0498	29/32	112.00
ES 0500	34/35	240.00
ES 0502	40/38	240.00
ES 0504	45/40	290.00

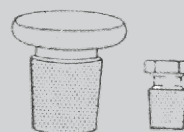

B - 24

S - 25 Stoppers Hollow (B SIZE), *Eswarr*

Cat. No.	Cone	Price
ES 0506	10/19	85.00
ES 0508	12/21	85.00
ES 0510	14/23	85.00
ES 0512	19/26	92.00
ES 0514	24/29	98.00
ES 0516	29/32	98.00
ES 0518	34/35	190.00
ES 0520	40/38	190.00
ES 0522	45/40	270.00



B - 25

Condensers
Air, Liebig

Eswarr

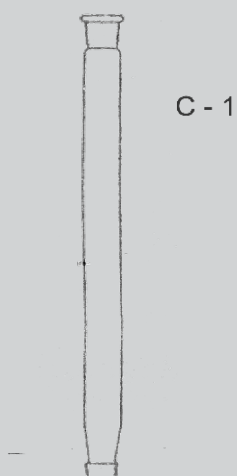

C - 1

C - 1 Condensers, Air, *Eswarr*

Cat. No.	Joint	Length mm	Price
ES 0524	19/26	200	460.00
ES 0526	19/26	300	460.00
ES 0528	19/26	400	540.00
ES 0530	19/26	500	590.00
ES 0532	19/26	600	790.00
ES 0534	24/29	400	630.00
ES 0536	24/29	600	810.00

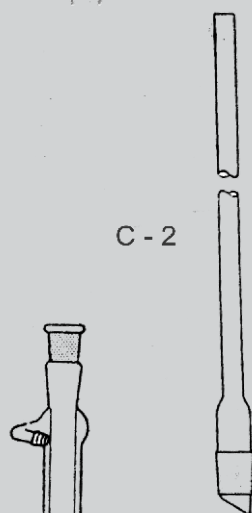

C - 2

C - 2 Condensers, Air, Vertical, *Eswarr*

Cat. No.	Cone	Length mm	Price
ES 0538	14/23	400	290.00
ES 0540	19/26	400	290.00
ES 0542	24/29	500	390.00

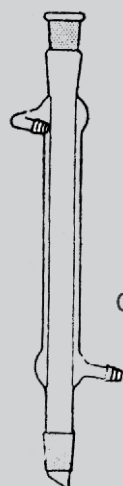

C - 3

C - 3 Condensers, Liebig, *Eswarr*

Cat. No.	Joint	Length mm	Price
ES 0544	19/26	200	460.00
ES 0546	19/26	300	460.00
ES 0548	19/26	400	490.00
ES 0550	19/26	500	610.00
ES 0552	24/29	200	450.00
ES 3281	24/29	300	450.00
ES 3282	24/29	400	510.00
ES 0558	24/29	500	610.00

C - 4 Condensers, Coil (GRAHAM), *Eswarr*

Cat. No.	Joint	Length mm	Price
ES 0560	19/26	150	610.00
ES 0562	19/26	300	650.00
ES 0564	24/29	150	610.00
ES 0568	24/29	300	710.00
ES 0570	29/32	150	650.00
ES 0572	29/32	300	810.00

C - 5 Condensers, Jacketed Coil, *Eswarr*

Cat. No.	Joint	Length mm	Price
ES 0574	19/26	150	1490.00
ES 0576	24/29	150	1490.00
ES 0578	29/32	150	1810.00

C - 6 Condensers, Inland Revenue (THORPE), *Eswarr*

Cat. No.	Joint	Length mm	Price
ES 0580	19/26	200	1790.00
ES 0582	24/29	200	1790.00

C - 7 Condensers, Vertical Distillate, *Eswarr*

Cat. No.	Cone	Height mm	Price
ES 0584	34/35	350	2450.00



C - 4



C - 5

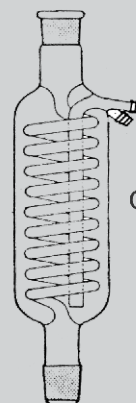

C - 6

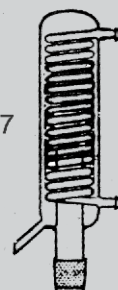

C - 7

Condensers
Double Surface

Eswarr

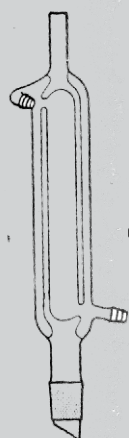

C - 9

C - 9 Condensers, Double Surface (DAVIES), *Eswarr*

Cat. No.	Joint	Length mm	Price
ES 0586	14/23	150	1050.00
ES 0588	19/26	200	1910.00
ES 0590	19/26	300	2110.00
ES 0592	24/29	200	1910.00
ES 0594	24/29	300	2110.00



C - 10

C - 10 Condensers, Allihn, *Eswarr*

Cat. No.	Joint	Length mm	Price
ES 0596	24/29	300	690.00
ES 0598	24/29	400	690.00
ES 0600	24/29	500	810.00
ES 0602	24/29	600	1100.00

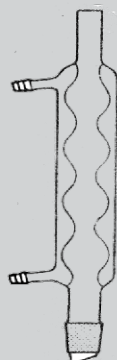

C - 11

C - 11 Condensers, Allihn, Vertical, *Eswarr*

Cat. No.	Joint	Length mm	Price
ES 0604	24/29	200	490.00
ES 0606	29/32	200	590.00
ES 0608	34/35	200	650.00
ES 0610	40/38	200	750.00

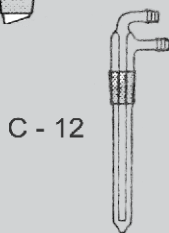

C - 12

C - 12 Condenser, Immersion (COLD FINGER), *Eswarr*

Cat. No.	Cone	Length mm	Price
ES 0612	19/26	100	351.00

Eswarr

Columns
Fractioning

C - 13 Fractioning Columns, Vigreux, *Eswarr*

Cat. No.	Socket	Cone	Length mm	Price
ES 0614	24/29	24/29	360	1052.00
ES 0616	24/29	24/29	600	1834.00
ES 0618	29/32	29/32	360	1344.00

C - 14 Fractioning Columns, Plain, *Eswarr*

Cat. No.	Socket	Cone	Length mm	Price
ES 0620	24/29	24/29	250	360.00
ES 0622	24/29	24/29	500	508.00
ES 0624	24/29	24/29	750	745.00
ES 0626	29/32	29/32	500	675.00
ES 0628	34/35	34/35	500	1195.00

C - 15 Spray for Chromatography, *Eswarr*

Cat. No.	Cap. Ml	Price
ES 0630	25	950.00
ES 0632	50	950.00
ES 3279	100	1250.00

C - 13

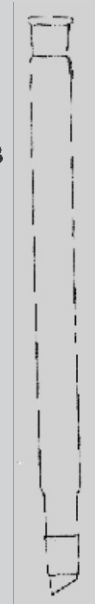

C - 14

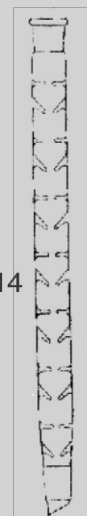

C - 14

Columns Chromatography

Eswarr

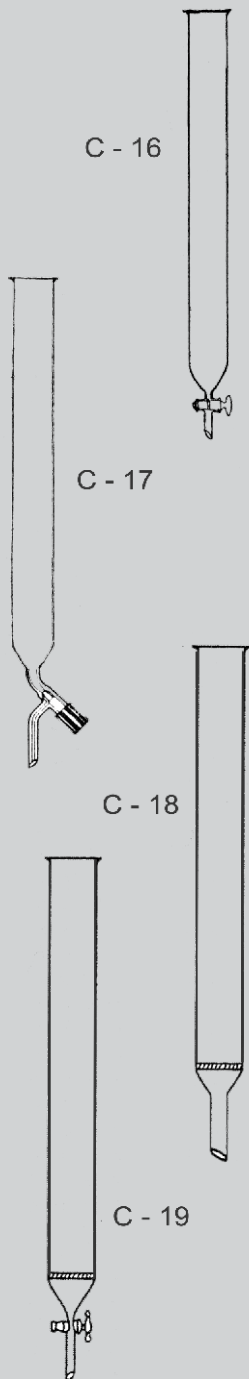

C - 16 Chromatography Columns, Plain with Stopcock, *Eswarr*

Cat. No.	Bore mm	Length mm	Price
ES 3271	10	300	340.00
ES 0638	18	300	390.00
ES 3272	18	450	490.00
ES 0642	30	450	510.00
ES 3273	30	600	690.00

C - 17 Columns, Chromatography, Plain with Screwcock, *Eswarr*

Cat. No.	Bore mm	Length mm	Price
ES 3274	10	300	290.00
ES 0648	18	300	340.00
ES 3275	18	450	490.00
ES 0652	30	450	545.00
ES 3276	30	600	670.00

C - 18 Chromatography Columns with Sintered Disc, *Eswarr*

Cat. No.	Bore mm	Length mm	Price
ES 3277	10	150	325.00
ES 0658	10	300	375.00
ES 3278	18	300	445.00
ES 0662	18	450	590.00
ES 0664	30	450	810.00
ES 3280	30	600	1050.00

C - 19 Chromatography Columns with Sintered Disc and Stopcock (PTFE PLUG), *Eswarr*

Cat. No.	Bore mm	Length mm	Price
ES 0668	10	150	510.00
ES 0670	10	300	590.00
ES 0672	18	300	710.00
ES 0674	18	450	810.00
ES 0676	30	450	910.00
ES 0678	30	600	950.00

Eswarr

Cylinders
Measuring

C- 20 Measuring Cylinders, with Spout, Class B, *Eswarr*

Cat. No.	Size	Sub-dvn. ml	Price
ES 3651	5	0.1	210.00
ES 3652	10	0.2	245.00
ES 3653	25	0.5	305.00
ES 3654	50	1	325.00
ES 3655	100	1	375.00
ES 3656	250	2	705.00
ES 3657	500	5	915.00
ES 3658	1000	10	1395.00
ES 3659	2000	20	2630.00

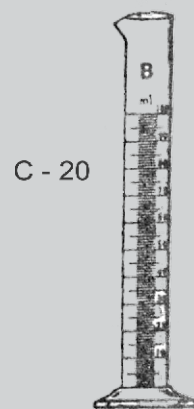

C- 21 Measuring Cylinders, Stoppered, Class B, *Eswarr*

Cat. No.	Cap.ml	Sub-dvn. ml	Price
ES 0700	10	0.2	375.00
ES 0702	25	0.5	415.00
ES 0704	50	1.0	470.00
ES 0706	100	1.0	560.00
ES 0708	250	2.0	975.00
ES 0710	500	5.0	1375.00
ES 0712	1000	10	1975.00
ES 0714	2000	20	3450.00

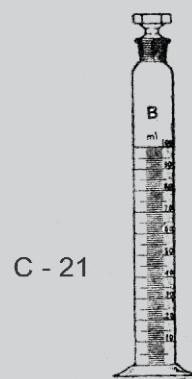

Cylinders,
Desiccators, Dishes

Eswarr

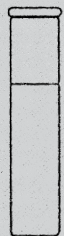

C - 21



C - 22

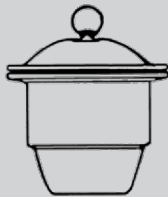

D - 1

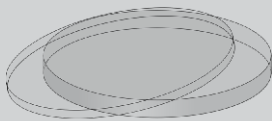

D - 2

C- 21 Nessler Cylinders, *Eswarr*

Cat. No.	Description	Tol +ml	Price
ES 3681	50 ml, single Marked at 25, 50	0.4	185.00
ES 3682	100 ml, single marked at 50, 100	0.8	270.00

C- 22 Crow Receivers, Class B, *Eswarr*

Cat. No.	Cone	Length mm	Price
ES 0720	25	0.1 & 0.2	579.00
ES 0722	50	0.2 & 0.4	614.00
ES 0724	100	0.4 & 0.8	653.00

D- 1 Desiccators, *Eswarr*

Cat. No.	ID	Price
ES 3315	100mm	5450.00
ES 3316	150mm	6100.00
ES 3317	200mm	7600.00
ES 3318	250mm	10110.00

D- 2 Dishes - Petri, *Eswarr*

Cat. No.	OD x Height	Price
ES 3711	50x17	165.00
ES 3712	80x17	205.00
ES 0738	100x15	120.00
ES 3713	100x17	245.00
ES 3714	150x20	605.00
ES 0744	200x20	1310.00

G - 1 Gooch (Sintered) Crucibles (WESTERN TYPE), *Eswarr*

Cat. No.	Cap.ml	Disc Dia mm	Por.	Price
ES 0746	15	20	1	350.00
ES 0748	15	20	2	350.00
ES 0750	15	20	3	350.00
ES 0752	15	20	4	350.00
ES 0754	30	30	1	490.00
ES 0756	30	30	2	490.00
ES 3261	30	30	3	490.00
ES 3262	30	30	4	490.00
ES 0762	50	40	1	590.00
ES 0764	50	40	2	590.00
ES 0766	50	40	3	590.00
ES 0768	50	40	4	590.00

G - 2 Adapters for Gooch Crucibles, *Eswarr*

Cat. No.	To fit	Price
ES 0770	15 ml crucibles of Catalogue No. S-1	115.00
ES 0772	30 ml crucibles of Catalogue No. S-1	155.00
ES 0774	50 ml crucibles of Catalogue No. S-1	235.00

G - 3 Adapters for Gooch Crucible with Standard Joints, *Eswarr*

Cat. No.	Cone	Socket	Price
ES 0776	29/32	40/26	450.00

G - 1



G - 2

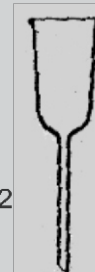

G - 3



Flask Round
& Flat Bottom

Eswarr

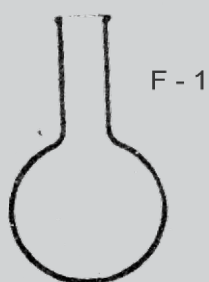

F - 1 Flask Round Bottom or Flat Bottom Plain, *Eswarr*

Cat. No.	Cap.ml	Price
ES 0778	25	85.00
ES 0780	50	93.00
ES 3381	100	105.00
ES 3382	250	120.00
ES 3383	500	195.00
ES 3384	1000	300.00
ES 3385	2000	595.00
ES 3386	3000	1890.00
ES 3387	5000	2595.00

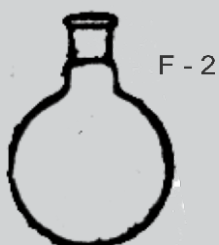

F - 2 Micro Round Bottom Flasks, Short Neck, *Eswarr*

Cat. No.	Cap. MI	Socket	Price
ES 0796	5	10/19	169.00
ES 0798	5	14/23	169.00
ES 0800	10	10/19	169.00
ES 0802	10	14/23	169.00
ES 0804	25	14/23	169.00
ES 0806	25	19/26	169.00
ES 0808	25	24/29	169.00

Eswarr

Flasks Round
Bottom Single Neck

F - 3 Round Bottom Flasks, Short Neck, *Eswarr*

Cat. No.	Cap.ml	Socket	Price
ES 0810	50	14/23	165.00
ES 0812	50	19/26	165.00
ES 0814	50	24/29	165.00
ES 3374	100	19/26	165.00
ES 0818	100	24/29	165.00
ES 0820	100	29/32	165.00
ES 0822	250	14/23	205.00
ES 0824	250	19/26	205.00
ES 3375	250	24/29	205.00
ES 0828	250	29/32	205.00
ES 0830	500	19/26	295.00
ES 3376	500	24/29	295.00
ES 0834	500	29/32	295.00
ES 0836	500	34/35	295.00
ES 3377	1000	24/29	405.00
ES 0840	1000	29/32	405.00
ES 0842	1000	34/35	405.00
ES 0844	1000	45/40	405.00
ES 0846	1000	55/44	405.00
ES 0848	2000	24/29	790.00
ES 3378	2000	29/32	790.00
ES 0852	2000	34/35	790.00
ES 0854	2000	45/40	790.00
ES 0856	3000	24/29	2190.00
ES 0858	3000	29/32	2190.00
ES 0860	3000	34/35	2190.00
ES 0862	3000	45/40	2250.00
ES 0864	3000	55/44	2250.00
ES 0866	5000	24/29	3410.00
ES 0868	5000	29/32	3410.00
ES 3379	5000	34/35	3410.00
ES 0872	5000	45/40	3540.00
ES 0874	5000	55/44	3540.00

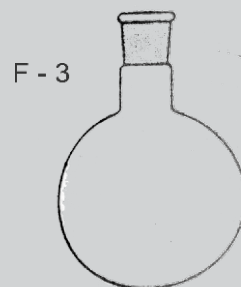

Flasks Round
Bottom Two Necks

Eswarr

F - 4 Round Bottom Flasks, Two Necks, Center Neck and
One Angled Side Neck, *Eswarr*



Cat. No.	Cap. MI	Center Socket	Side Socket	Price
ES 0876	100	24/29	14/23	210.00
ES 0878	100	24/29	19/26	210.00
ES 0880	250	24/29	14/23	310.00
ES 3388	250	24/29	19/26	310.00
ES 0884	500	24/29	14/23	445.00
ES 3389	500	24/29	19/26	445.00
ES 0888	1000	24/29	14/23	555.00
ES 3390	1000	24/29	19/26	555.00
ES 0892	2000	24/29	14/23	990.00
ES 0894	2000	24/29	19/26	990.00
ES 0896	2000	34/35	19/26	990.00
ES 0898	3000	34/35	19/26	2670.00
ES 0900	5000	34/35	19/26	3920.00

Eswarr

Flasks Round
Bottom Three Necks

F - 5 Round Bottom Flasks, Three Necks, Centre Neck and
Two Angled Side Neck, *Eswarr*

Cat. No.	Cap. ml	Centre Socket	Side Socket	Price
ES 0902	100	14/23	14/23	310.00
ES 0904	100	19/26	14/23	310.00
ES 0906	100	24/29	14/23	310.00
ES 0908	100	24/29	19/26	310.00
ES 0910	250	19/26	14/23	420.00
ES 0912	250	19/26	19/26	420.00
ES 0914	250	24/29	14/23	420.00
ES 3397	250	24/29	19/26	420.00
ES 0918	250	29/32	14/23	420.00
ES 0920	250	29/32	19/26	420.00
ES 0922	500	19/26	14/23	640.00
ES 0924	500	19/26	19/26	640.00
ES 0926	500	24/29	14/23	640.00
ES 3398	500	24/29	19/26	640.00
ES 0930	500	29/32	14/23	640.00
ES 0932	500	29/32	19/26	640.00
ES 0934	1000	24/29	14/23	740.00
ES 0936	1000	24/29	19/26	740.00
ES 3399	1000	34/35	19/26	740.00
ES 0940	2000	24/29	14/23	1360.00
ES 0942	2000	24/29	19/26	1360.00
ES 0944	2000	34/35	19/26	1360.00
ES 0946	3000	34/35	19/26	3445.00
ES 0948	5000	34/35	19/26	4865.00

F - 5

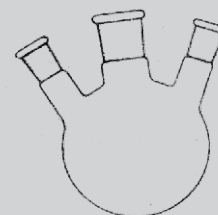

Flasks
Flat Bottom

Eswarr

F - 6 Flat Bottom Flasks, Short Neck, *Eswarr*

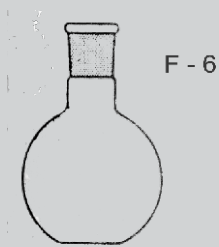

Cat. No.	Cap.ml	Socket	Price
ES 0950	50	24/29	165.00
ES 0952	50	29/32	165.00
ES 0954	50	34/35	165.00
ES 0956	100	19/26	165.00
ES 0958	100	24/29	165.00
ES 0960	100	29/32	165.00
ES 0962	100	34/35	165.00
ES 0964	250	19/26	205.00
ES 0966	250	24/29	205.00
ES 0968	250	29/32	205.00
ES 0970	250	34/35	205.00
ES 0972	500	19/26	295.00
ES 0974	500	24/29	295.00
ES 0976	500	29/32	295.00
ES 0978	500	34/35	295.00
ES 0980	1000	24/29	405.00
ES 0982	1000	29/32	405.00
ES 0984	1000	34/35	405.00
ES 0986	2000	24/29	790.00
ES 0988	2000	29/32	790.00
ES 0990	2000	34/35	790.00

Eswarr

Flasks
Conical

F - 7 Flask Conical Plain, *Eswarr*

Cat. No.	Cap. Ml	Price
ES 3351	25	90.00
ES 3353	50	90.00
ES 3354	100	90.00
ES 3355	150	110.00
ES 3356	250	135.00
ES 3357	500	190.00
ES 3358	1000	340.00
ES 3359	2000	580.00

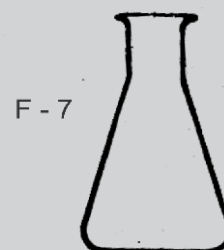

F - 8 Conical Flasks Ground Joint, *Eswarr*

Cat. No.	Cap.ml	Socket	Price
ES 1008	50	14/23	170.00
ES 1010	50	19/26	170.00
ES 1012	50	24/29	170.00
ES 1014	100	14/23	195.00
ES 1016	100	19/26	195.00
ES 1018	100	24/29	195.00
ES 1020	100	29/32	195.00
ES 1022	250	19/26	210.00
ES 1024	250	24/29	210.00
ES 1026	250	29/32	240.00
ES 1028	250	34/35	240.00
ES 1030	500	19/26	305.00
ES 1032	500	24/29	305.00
ES 1034	500	29/32	345.00
ES 1036	500	34/35	345.00
ES 1038	1000	24/29	565.00
ES 1040	1000	29/32	565.00
ES 1042	1000	34/35	565.00

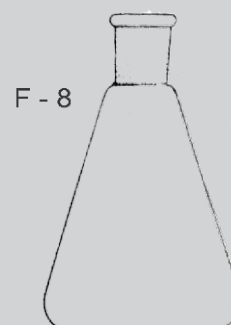

Flasks Filter,
Iodine, Conical Stopper

Eswarr

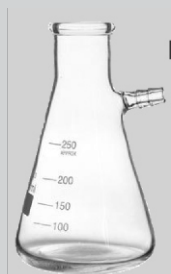

F - 9

F - 9 Filter Flasks, Light Walled, *Eswarr*

Cat. No.	Cap. MI	Socket	Price
ES 1044	100	19/26	295.00
ES 1046	100	24/29	295.00
ES 3406	250	24/29	430.00
ES 1050	250	29/32	430.00
ES 3407	500	24/29	520.00
ES 1054	500	29/32	520.00
ES 3408	1000	29/32	795.00



F - 10

F - 10 Iodine Flasks, Cup Shaped, *Eswarr*

Cat. No.	Cap. MI	Socket	Price
ES 3420	100	24/29	190.00
ES 3421	250	24/29	245.00
ES 3422	500	24/29	315.00
ES 3423	1000	24/29	495.00



F - 11

F - 11 Stoppered Conical Flasks, *Eswarr*

Cat. No.	Cap. MI	Socket	Price
ES 1066	50	19/20	240.00
ES 1068	100	19/20	275.00
ES 1070	150	24/25	290.00
ES 1072	250	24/25	315.00
ES 1074	500	24/25	315.00

Eswarr

Flasks
Kjeldahl, Volumetric

F - 12 Kjeldahl Flasks, Long Neck, *Eswarr*

Cat. No.	Cap. MI	Socket	Price
ES 1076	100	24/29	190.00
ES 3413	300	24/29	305.00
ES 3414	500	24/29	590.00
ES 3415	800	24/29	710.00

F - 12

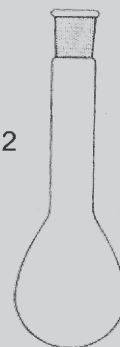

F - 13 Flask Volumetric with I/C Joint Stopper, Class B, *Eswarr*

Cat. No.	Cap. MI	Stopper Size	Price
ES 1084	5	10/15	215.00
ES 3452	10	10/15	215.00
ES 3453	25	10/15	215.00
ES 3454	50	10/15	235.00
ES 3455	100	24/25	260.00
ES 3456	250	14/15	305.00
ES 3457	500	14/15	415.00
ES 3458	1000	19/20	625.00

F - 13

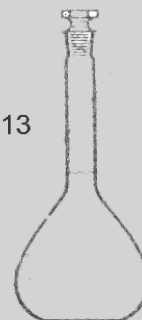

Flasks
Pear Shaped

Eswarr

F - 14



F - 14 Pear Shaped Flasks, Single Neck, *Eswarr*

Cat. No.	Cap. MI	Socket	Price
ES 1100	25	10/19	146.00
ES 1102	25	14/23	146.00
ES 1104	25	19/26	146.00
ES 1106	50	14/23	209.00
ES 1108	50	19/26	209.00
ES 1110	100	14/23	276.00
ES 1112	100	19/26	276.00

F - 15

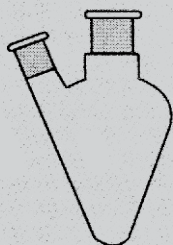

F - 15 Pear Shaped Flasks, Two Necks, Center Neck
and One Angled Side Neck, *Eswarr*

Cat. No.	Cap. MI	Center Socket	Side Socket	Price
ES 1114	50	14/23	14/23	308.00

F - 16

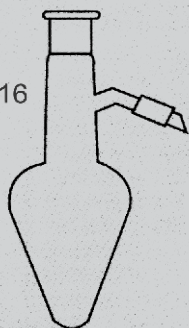

F - 16 Pear Shaped Flasks, Distillation, *Eswarr*

Cat. No.	Cap. MI	Socket	Cone	Price
ES 1116	25	14/23	14/23	281.00
ES 1118	50	14/23	14/23	308.00
ES 1120	100	14/23	14/23	363.00

*Eswarr*Flasks
GraduatedF - 17 Sugar Flasks, with Two Marks, Class B, *Eswarr*

Cat. No.	Cap. ml	Marked at	Tol ±ml	Price
ES 1122	50	50 & 55	0.1	210.00
ES 1124	100	100 & 110	0.15	290.00
ES 1126	200	200 & 220	0.25	340.00



F - 17

F - 18 Kohlrausch Flasks, Class B, *Eswarr*

Cat. No.	Cap. ml	Tol ±ml	Price
ES 1128	50	0.06	240.00
ES 1130	100	0.1	270.00
ES 1132	200	0.2	295.00

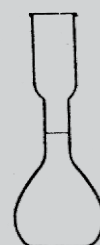

F - 18

F - 19 Saybolt Viscosity Flask, *Eswarr*

Cat. No.	Cap. ml	Height mm	Price
ES 1134	60	85	540.00

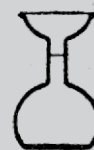

F - 19

F - 20 Phenol Flasks, *Eswarr*

Cat. No.	Bulb cap.	Neck cap.	Sub- divn. ml	Tol ±ml	Price
ES 1136	45	5	0.1	0.08	447.00
ES 1138	150	10	0.1	0.08	561.00
ES 1140	200	25	0.2	0.2	644.00



F - 20

Funnels
Filter

Eswarr

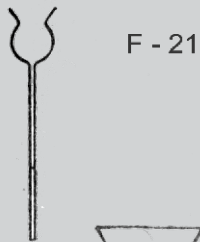

F - 21

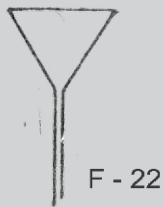

F - 22

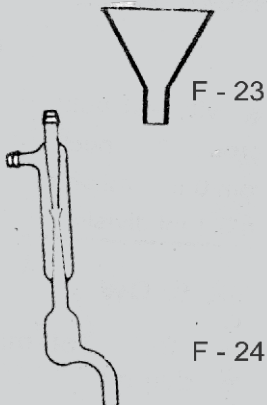

F - 23

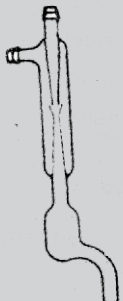

F - 24

F - 21 Funnel with Thistle Head, *Eswarr*

Cat. No.	Stem Dia x Length mm	Price
ES 3535	7 x 300	95.00

F - 22 Filter Funnels, *Eswarr*

Cat. No.	Dia. Mm	Price
ES 3511	50	105.00
ES 3513	75	135.00
ES 3514	100	175.00

F - 23 Funnels Powder, Short Stem (FOR POWDER), *Eswarr*

Cat. No.	Dia. Mm	Price
ES 1150	75	190.00
ES 1152	100	285.00

F - 24 Filter Pump, *Eswarr*

Cat. No.	Description	Price
ES 3541	University College pattern	404.00

Eswarr

Funnels
Separating

F - 25 Separating Funnels, Cylindrical, *Eswarr*

Cat. No.	Cap. ml	Price
ES 1156	100	613.00
ES 1158	250	722.00
ES 1160	500	944.00
ES 1162	1000	1509.00

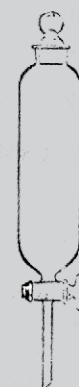

F - 25

F - 26 Separating Funnels, with PTFE Plug, Cylindrical, *Eswarr*

Cat. No.	Cap. ml	Price
ES 1164	100	977.00
ES 1166	250	1066.00
ES 1168	500	1513.00
ES 1170	1000	2048.00

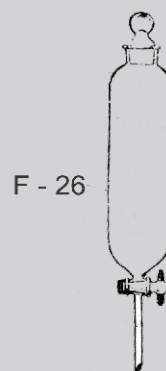

F - 26

F - 27 Separating Funnels, Cylindrical, Graduated, *Eswarr*

Cat. No.	Cap. ml	Price
ES 1172	100	1106.00
ES 1174	250	1203.00
ES 1176	500	1931.00
ES 1178	1000	2919.00

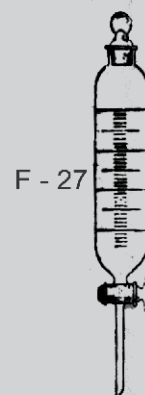

F - 27

Funnels Separating

Eswarr

F - 28 Separating Funnels, with PTFE Plug, Cylindrical Graduated, *Eswarr*



Cat. No.	Cap. ml	Price
ES 1180	100	1368.00
ES 1182	250	1535.00
ES 1184	500	2341.00
ES 1186	1000	3228.00

F - 29 Separating Funnels, Spherical, *Eswarr*

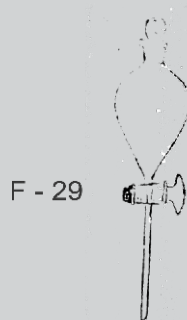

Cat. No.	Cap. ml	Price
ES 1188	60	690.00
ES 1190	100	890.00
ES 1192	125	890.00
ES 1194	250	990.00
ES 1196	500	1290.00
ES 1198	1000	1790.00

F - 30 Separating Funnels, with PTFE Plug, Spherical, *Eswarr*

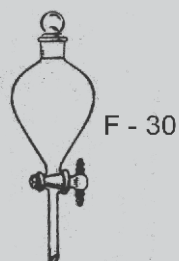

Cat. No.	Cap. ml	Price
ES 1200	60	840.00
ES 1202	100	990.00
ES 1204	125	990.00
ES 1206	250	1190.00
ES 1208	500	1490.00
ES 1210	1000	1990.00

F - 31 Separating Funnels, Cylindrical, Open Top, *Eswarr*

Cat. No.	Cap. ml	Price
ES 1212	25	372.00
ES 1214	50	372.00
ES 1216	100	492.00
ES 1218	250	630.00

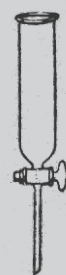

F - 31

F - 32 Separating Funnels, Conical, *Eswarr*

Cat. No.	Cap. ml	Price
ES 3521	60	490.00
ES 1222	100	575.00
ES 3522	125	575.00
ES 3524	250	690.00
ES 3525	500	840.00
ES 3526	1000	1290.00



F - 32

F - 33 Separating Funnels, with PTFE Plug, Conical, *Eswarr*

Cat. No.	Cap. ml	Price
ES 1232	60	690.00
ES 1234	100	860.00
ES 1236	125	860.00
ES 1238	250	990.00
ES 1240	500	1290.00
ES 1242	1000	1490.00



F - 33

Funnels Separating

Eswarr

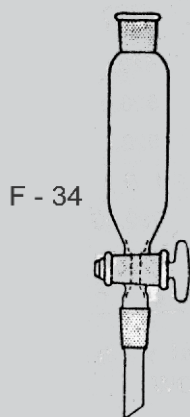

F - 34 Separating Funnels, Cylindrical, *Eswarr*

Cat. No.	Cap. MI	Socket	Cone	Price
ES 1244	25	14/23	14/23	544.00
ES 1246	50	14/23	14/23	544.00
ES 1248	100	14/23	14/23	674.00
ES 1250	100	19/26	19/26	674.00
ES 1252	250	19/26	19/26	785.00
ES 1254	500	19/26	19/26	1396.00

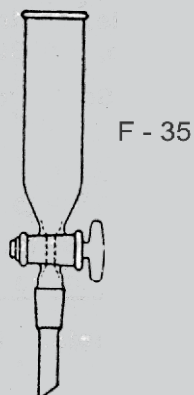

F - 35 Separating Funnels, Open Top, *Eswarr*

Cat. No.	Cap. MI	Cone	Price
ES 1256	50	19/26	468.00
ES 1258	100	19/26	593.00
ES 1260	250	19/26	730.00

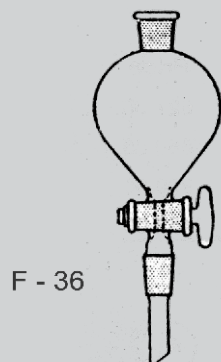

F - 36 Separating Funnels, Spherical, *Eswarr*

Cat. No.	Cap. MI	Socket	Cone	Price
ES 1262	50	19/16	19/16	486.00
ES 1264	100	14/23	14/23	574.00
ES 1266	100	19/26	19/26	574.00
ES 1268	250	14/23	14/23	720.00
ES 1270	250	19/26	19/26	720.00
ES 1272	500	19/26	19/26	1157.00
ES 1274	500	24/29	24/29	1157.00
ES 1276	1000	19/26	19/26	1586.00
ES 1278	1000	24/29	24/29	1586.00

Eswarr

Funnels
Pressure Equalizing

F - 37 Pressure Equalizing Funnels Spherical, *Eswarr*

Cat. No.	Cap. MI	Socket	Cone	Price
ES 1280	100	24/29	19/26	1190.00
ES 1282	100	24/29	24/29	1190.00
ES 1284	100	29/32	29/32	1190.00
ES 1286	250	24/29	19/26	1410.00
ES 1288	250	24/29	24/29	1410.00
ES 1290	250	29/32	29/32	1410.00



F - 37

F - 38 Pressure Equalizing Funnels Cylindrical, *Eswarr*

Cat. No.	Cap. MI	Socket	Cone	Price
ES 1292	500	24/29	19/16	2290.00
ES 1294	500	24/29	24/29	2290.00
ES 1296	500	29/32	29/32	2290.00



F - 38

Pipettes
Volumetric

Eswarr

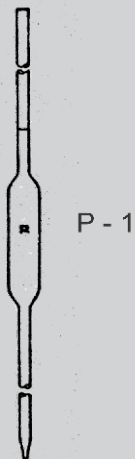

P - 1 Volumetric Pipettes, One Mark, Class B, *Eswarr*

Cat. No.	Cap. ml	Tol ±ml	Price
ES 3751	1	0.015	115.00
ES 3752	2	0.02	115.00
ES 1302	3	0.03	115.00
ES 1304	4	0.03	115.00
ES 3753	5	0.03	125.00
ES 3754	10	0.04	140.00
ES 1310	15	0.05	140.00
ES 3755	20	0.06	160.00
ES 3756	25	0.06	160.00
ES 3757	50	0.10	210.00
ES 3758	100	0.16	290.00

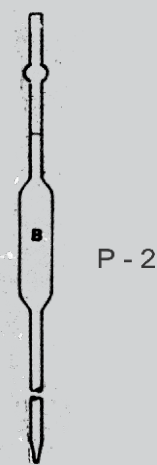

P - 2 Volumetric Pipettes One Mark, With Safety Bulb Class B, *Eswarr*

Cat. No.	Cap. ml	Tol ±ml	Price
ES 1320	5	0.03	125.00
ES 1322	10	0.04	125.00
ES 1324	20	0.06	175.00
ES 1326	25	0.06	175.00

Eswarr

Pipettes
Automatic

P - 3 Automatic Pipettes, with Overflow Cap, *Eswarr*

Cat. No.	Cap.ml	Tol \pm ml	Price
ES 1328	10	0.08	1450.00
ES 1330	20	0.1	1450.00
ES 1332	25	0.12	1450.00
ES 1334	50	0.15	1450.00
ES 1336	100	0.25	1450.00

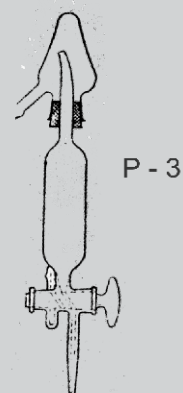

P - 4 Tilt Measures, with Ground Reservoir, *Eswarr*

Cat. No.	Cap.ml	Reservoir Cap. MI	Price
ES 1338	5	250	793.00
ES 1340	10	250	793.00
ES 1342	20	500	810.00
ES 1344	25	500	890.00

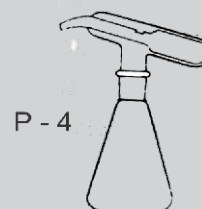

P - 5 Tilt Measures, Measure only, without Reservoir, *Eswarr*

Cat. No.	Cap.ml	Price
ES 1346	5	610.00
ES 1348	10	640.00
ES 1350	20	690.00
ES 1352	25	790.00



Pipettes
Graduated

Eswarr

P - 6 Measuring Pipettes. Zero at Top, Class B, (MOHR TYPE) *Eswarr*

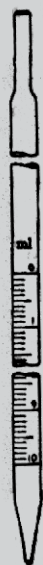

P - 6



Cat. No.	Cap.ml	Sub-dvn. ml	Tol ±ml	Price
ES 1354	0.1	0.005	0.01	125.00
ES 3740	0.1	0.01	0.01	125.00
ES 1358	0.2	0.005	0.01	125.00
ES 3741	0.2	0.01	0.01	125.00
ES 1362	0.5	0.01	0.01	125.00
ES 3742	0.5	0.02	0.01	125.00
ES 1366	1.0	0.01	0.01	125.00
ES 3743	1.0	0.1	0.01	125.00
ES 1370	2.0	0.02	0.02	125.00
ES 3744	2.0	0.1	0.02	125.00
ES 1374	5.0	0.05	0.05	145.00
ES 3745	5.0	0.01	0.05	145.00
ES 3746	10.0	0.1	0.1	145.00
ES 3748	25.0	0.2	0.2	245.00



P - 7

P - 7 Drain-Out Pipettes, Zero at Jet, Class B, *Eswarr*
To Transfer pre-set volume, without ejection of last drop

Cat. No.	Cap. ml	Sub-dvn. ml	Tol ±ml	Price
ES 1382	0.1	0.005	0.01	125.00
ES 1384	0.1	0.01	0.01	125.00
ES 1386	0.2	0.005	0.01	125.00
ES 1388	0.2	0.01	0.01	125.00
ES 1390	0.5	0.01	0.01	125.00
ES 1392	0.5	0.02	0.01	125.00

Eswarr

Pipettes
Graduated

ES 1394	1.0	0.01	0.01	125.00
ES 1396	1.0	0.1	0.01	125.00
ES 1398	2.0	0.02	0.02	125.00
ES 1400	2.0	0.1	0.02	125.00
ES 1402	5.0	0.05	0.05	145.00
ES 1404	5.0	0.01	0.05	145.00
ES 1406	10.0	0.01	0.1	145.00
ES 1408	25.0	0.2	0.2	245.00

P - 8 Blow-Out Pipettes, Zero at Top, Class B *Eswarr*
(SEROLOGICAL)

Cat. No.	Cap. ml	Sub-dvn. ml	Tol \pm ml	Price
ES 1410	0.1	0.005	0.01	125.00
ES 1412	0.1	0.01	0.01	125.00
ES 1414	0.2	0.005	0.01	125.00
ES 1416	0.2	0.01	0.01	125.00
ES 1418	0.5	0.01	0.01	125.00
ES 1420	0.5	0.02	0.01	125.00
ES 1422	1.0	0.01	0.01	125.00
ES 1424	1.0	0.1	0.01	125.00
ES 1426	2.0	0.02	0.02	125.00
ES 1428	2.0	0.1	0.02	125.00
ES 1430	5.0	0.05	0.05	145.00
ES 1432	5.0	0.1	0.05	145.00
ES 1434	10.0	0.1	0.1	145.00
ES 1436	25.0	0.2	0.2	245.00

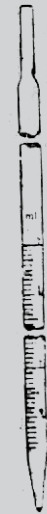

P - 8

Stirrers
Glass

Eswarr

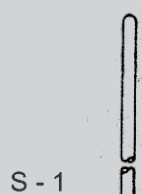

S - 1

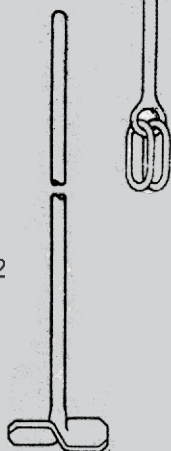

S - 2

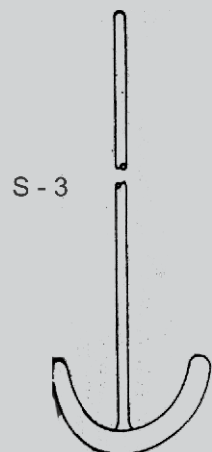

S - 3

S - 1 Link Stirrers, *Eswarr*

Cat. No.	Shaft Dia mm	Shaft Length mm	Blade width mm	Price
ES 1438	6	450	75	390.00
ES 1440	6	600	75	460.00

S - 2 Fixed Paddle Stirrers, *Eswarr*

Cat. No.	Shaft Dia mm	Shaft Length mm	Blade width mm	Price
ES 1442	6	600	50	545.00
ES 1444	11	750	80	955.00

S - 3 Anchor Stirrers, *Eswarr*

Cat. No.	Shaft Dia mm	Shaft Length mm	Blade width mm	Price
ES 1446	6	450	95	593.00
ES 1448	6	600	140	621.00
ES 1450	11	750	140	890.00

Eswarr

Stirrer Guides
Glass

S - 4 Shaft for PTFE Bladed Stirrers, *Eswarr*

Cat. No.	Shaft Dia mm	Shaft Length mm	Price
ES 1452	6	450	299.00
ES 1454	8	600	394.00
ES 1456	11	750	594.00



S - 4

S - 5 Stirrers Guides, *Eswarr*

Cat. No.	To Fit Shaft mm	Socket	Cone	Shaft Length mm	Price
ES 1458	6	19/26	19/26	200	390.00
ES 1460	11	24/29	24/29	350	470.00
ES 1462	11	29/32	29/32	350	540.00

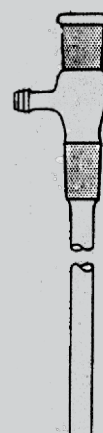

S - 5

S - 6 Glass Dropper, *Eswarr*

Cat. No.	Size	Price
ES 3291	4"	45.00
ES 3292	6"	60.00
ES 3293	8"	75.00



S - 6

Tubes
Test

Eswarr

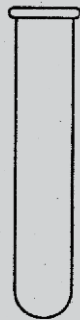

T - 1

T - 1 Test Tubes with RIM, *Eswarr*

Cat. No.	Approximate O.D. x Length mm	Qty Per Case	Each Price
ES 3011	3 ml	100	8.00
ES 3012	5 ml	100	8.00
ES 3013	7 ml	100	12.00
ES 3014	15 ml	100	15.00
ES 3015	20 ml	100	14.00
ES 3016	25 ml	100	20.00
ES 1482	25 x 100	100	25.00
ES 3017	50 ml	50	30.00
ES 1486	25 x 200	50	39.00
ES 1488	32 x 200	50	60.00
ES 1490	38 x 200	50	75.00

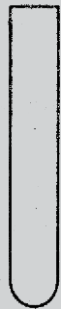

T - 2

T - 2 Test Tube without RIM, *Eswarr*

Cat. No.	Approximate O.D. x Length mm	Qty Per Case	Each Price
ES 3021	3 ml	100	8.00
ES 3022	5 ml	100	8.00
ES 3023	7 ml	100	13.00
ES 3024	15 ml	100	15.00
ES 3025	20 ml	100	17.00
ES 3026	25 ml	100	19.00
ES 1505	25 x 100	100	25.00
ES 3027	50 ml	50	30.00
ES 1508	25 x 200	50	32.00
ES 1510	32 x 200	50	60.00
ES 1512	38 x 200	50	75.00

Eswarr

Tubes
Test

T - 3 Test Tubes, Stoppered, *Eswarr*

Cat. No.	Cap. ml	Height x Dia mm	Joint	Price
ES 1514	15	150x16	14/15	135.00
ES 1516	20	150x18	14/15	145.00
ES 1518	30	150x24	19/20	190.00
ES 1520	40	150x28	24/25	190.00
ES 1522	50	175x28	24/25	235.00

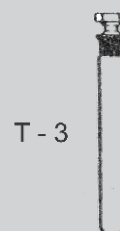

T - 4 Test Tubes, Stoppered and Graduated, *Eswarr*

Cat. No.	Cap. ml	Sub-Division mm	Height x Dia mm	Joint	Price
ES 1524	15	0.2	150x16	14/15	135.00
ES 1526	20	0.5	150x18	14/15	160.00
ES 1528	30	0.5	150x24	19/20	210.00
ES 1530	40	1.0	150x28	24/25	210.00
ES 1532	50	1.0	175x28	24/25	240.00



T - 5 Melting Point Tubes, Thiele, *Eswarr*

Cat. No.	Length x Dia mm	Side tube Dia mm	Price
ES 3941	120 x 20	10	168.00
ES 3942	150 x 25	10	192.00

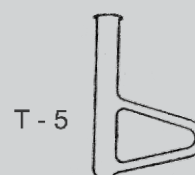

Tubes
Centrifuge

Eswarr



T - 6

T - 6 Centrifuge Tubes, Plain, with Rim, Conical Bottom, *Eswarr*

Cat. No.	Height x Dia mm	Price
ES 3877	10ml	48.00
ES 3871	15ml	48.00



T - 7

T - 7 Centrifuge Tubes, Graduated, with Rim, Conical Bottom *Eswarr*

Cat. No.	Height x Dia mm	Graduated upto	Price
ES 1542	110 x 17	10ml	90.00
ES 3872	120 x 17	15ml	90.00



T - 8

T - 8 Centrifuge Tubes, Plain, Stoppered, *Eswarr*

Cat. No.	Height x Dia mm	Joint	Price
ES 1546	110 x 17	12/14	148.00
ES 1548	140 x 17	14/15	148.00



T - 6

T - 6 Centrifuge Tubes, Graduated, Stoppered, *Eswarr*

Cat. No.	Height x Dia mm	Joint	Graduated upto	Price
ES 1550	110 x 17	12/14	10ml	190.00
ES 1552	140 x 17	14/15	15ml	190.00

Eswarr

Centrifuge Vessel,
Calcium Chloride Tubes

T - 7 Centrifuge Vessel, (SPHERICAL), *Eswarr*

Cat. No.	Cap. MI	Height mm	Price
ES 1554	100	157	850.00

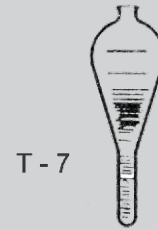

T - 8 Centrifuge Vessel, (CYLINDRICAL), *Eswarr*

Cat. No.	Cap.ml	Height mm	Price
ES 1556	100	200	850.00

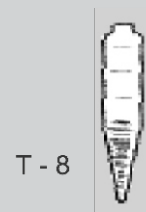

T - 9 Calcium Chloride Tubes, Straight with One Bulb, *Eswarr*

Cat. No.	Lenght x Dia mm	Price
ES 1558	100 x 14	90.00
ES 1560	125 x 16	110.00
ES 1562	150 x 18	125.00

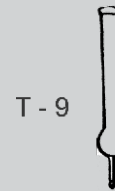

T - 10 Calcium Chloride Tubes, U-Form with Side
Tube and Stopper, *Eswarr*

Cat. No.	Length x Dia mm	Side tube Dia mm	Price
ES 1564	100 x 14	10/19	610.00
ES 1566	125 x 16	12/21	690.00
ES 1568	150 x 18	14/23	730.00

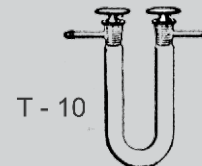

Tubes
Connecting

Eswarr



T - 11

T - 11 Blood Sugar Tubes, *Eswarr*

Cat. No.	Cap. ml	Dia. mm	Height mm	Graduated at ml	Price
ES 1570	25	22	190	12.5 & 25	205.00
ES 1572	25	22	190	4, 12.5 & 25	205.00

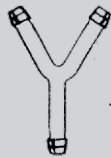

T - 12

T - 12 Connection Tubes, Y Shape, *Eswarr*

Cat. No.	Arm Length x Dia mm	Price
ES 1574	40 x 6	62.00
ES 1576	50 x 8	69.00
ES 1578	60 x 10	114.00
ES 1580	80 x 12	239.00

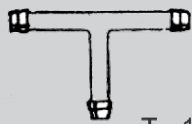

T - 13

T - 13 Connection Tubes, T Shape, *Eswarr*

Cat. No.	Arm Length x Dia mm	Price
ES 1582	40 x 6	59.00
ES 1584	50 x 8	63.00
ES 1586	60 x 10	76.00
ES 1588	80 x 12	149.00



T - 14

T - 14 Connection Tubes, U Shape, *Eswarr*

Cat. No.	Arm Length x Dia mm	Price
ES 1590	40 x 6	62.00
ES 1592	50 x 8	69.00
ES 1594	60 x 10	114.00
ES 1596	80 x 12	237.00

T - 15 Culture Tube, Round Bottom, with Screw Cap, *Eswarr*

Cat. No.	Cap.ml	Height x Dia mm	Price
ES 3881	5	75 x 16	57.00
ES 3882	10	125 x 16	65.00
ES 3885	30	100 x 25	79.00
ES 1604	50	150 x 25	85.00
ES 3886	60	200 x 25	85.00

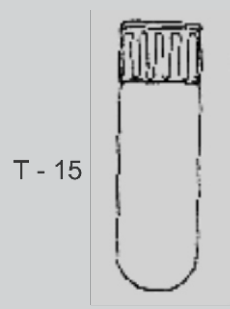

T - 16 Culture Tube, Flat Bottom, with Screw Cap, *Eswarr*

Cat. No.	Cap.ml	Height x Dia mm	Price
ES 3891	5	50 x 16	52.00
ES 3883	10	50 x 25	65.00
ES 3892	15	57 x 25	65.00
ES 1614	20	72 x 25	70.00
ES 3893	30	95 x 25	70.00
ES 1618	50	145 x 25	79.00

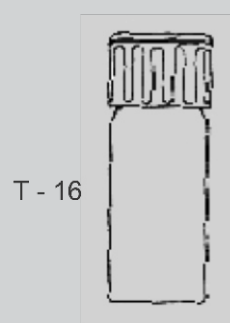

T - 17 Dilatometer, *Eswarr*

Cat. No.	Description	Price
ES 1620	The body is graduated with an arbitrary scale with 14/23 joints	950.00



T - 18 Pyknometers, *Eswarr*

Cat. No.	Cap. ml	Price
ES 1622	10	140.00
ES 1624	20	175.00
ES 1626	25	175.00
ES 1628	50	260.00

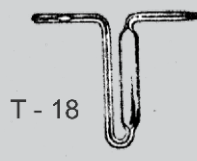

Viscometers
BS & IP

Eswarr



V - 1

V - 1 Viscometer, U-Tubs, BS/U, *Eswarr*

Cat. No.	Size	Nominal Constant	Viscosity Range	Price
ES 1630	B	0.01	2.0-10	2200.00
ES 1632	C	0.03	6-30	2200.00
ES 1634	D	0.1	20-100	2200.00
ES 1636	E	0.3	60-300	2200.00
ES 1638	F	1.0	200-1000	2200.00
ES 1640	G	3.0	600-3000	2200.00
ES 1642	H	10.0	2000-10000	2200.00

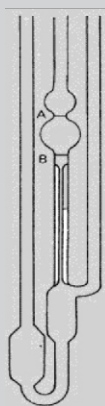

V - 2

V - 2 Viscometer, Suspended Level, BS/IP/SL, *Eswarr*

Cat. No.	Size	Nominal Constant	Viscosity Range	Price
ES 1644	1	0.01	3.5-10	3100.00
ES 1646	2	0.1	20-100	3100.00
ES 1648	3	1.0	200-1000	3100.00
ES 1650	4	10.0	2000-10000	3100.00
ES 1652	5	100.0	20000-100000	3100.00



V - 3

V - 3 Viscometers, College Pattern, Ostwald, *Eswarr*

Cat. No.	Empties in	Price
ES 3815	80 - 100 secs	1670.00

Eswarr

Assemblies
Reflux

X - 1 Reflux Assembly, *Eswarr*

Cat. No.	Components	Price
ES 1656	R.B. flask 100 ml, Air condenser 500 mm	560.00

X - 2 Reflux Assembly, *Eswarr*

Cat. No.	Components	Price
ES 1658	R.B. flask 100 ml, Liebig condenser 300 mm	710.00
ES 1660	R.B. flask 250 ml, Liebig condenser 400 mm	920.00
ES 1662	R.B. flask 500 ml, Liebig condenser 500 mm	1210.00

X - 3 Reflux Assemblies, *Eswarr*

Cat. No.	Components	Price
ES 1664	R.B. flask 100 ml, Liebig condenser 300 mm	820.00
ES 1666	R.B. flask 250 ml, Liebig condenser 400 mm	1010.00
ES 1668	R.B. flask 500 ml, Liebig condenser 500 mm	1390.00

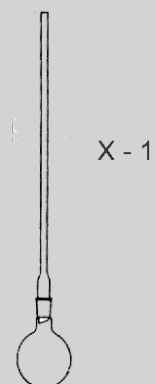

X - 1

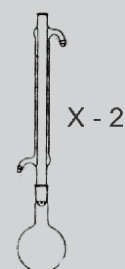

X - 2

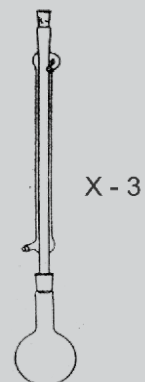

X - 3

Assemblies
Reflux

Eswarr

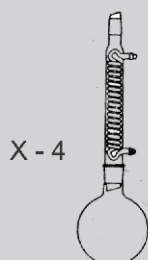

X - 4

X - 4 Reflux Assemblies, *Eswarr*

Cat. No.	Components	Price
ES 1670	R.B. flask 1000 ml, (24/29 neck), Reversible condenser	2100.00
ES 1672	R.B. flask 1000 ml, (34/35 neck), Reversible condenser	2300.00

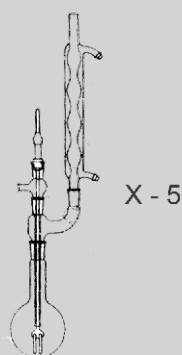

X - 5

X - 5 Reflux Assembly, *Eswarr*

Cat. No.	Components	Price
ES 1674	R.B. flask 500 ml, Multiple adapter two necks, Stirrer guide, Rubber sleeve gland, Link stirrer, 450 mm, Vertical Allihn condenser, 300 mm	2900.00

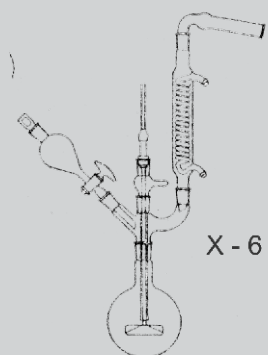

X - 6

X - 6 Reflux Assembly, *Eswarr*

Cat. No.	Components	Price
ES 1676	R.B. flask 1000 ml, Multiple adapter three necks, Stirrer guide, Rubber sleeve gland, Collapsible paddle stirrer, 450 mm, Coil condenser, 150 mm Drying tube, Separating Funnel 100 ml, Stopper	4350.00

Eswarr

Assemblies
Reaction

X - 7 Reaction Assembly, *Eswarr*

Cat. No.	Components	Price
ES 1678	Round Bottom Flask 1000 ml Multiple adapter three necks, Mercury seal gland, Fixed paddle stirrer 600 mm, Still head, Thermometer, with P.T.F.E. cone, Receiver adapter, Jacketed coil condenser 150 mm, Receiver adapter, bent with socket connection, R.B flask 250 ml, Liebig condenser 400 mm, Drying tube, Separating funnel 250 ml, Stopper	9950.00

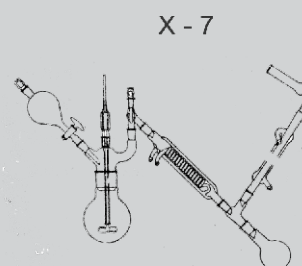

X - 8 Reaction Assembly, *Eswarr*

Cat. No.	Components	Price
ES 1680	Round Bottom Flask 500 ml, Multiple adapter two necks, Stirrer guide, Stuffing box gland with pulley, Link stirrer 450 mm, Still head, Thermometer pocket, Liebig condenser 400 mm, Receiver adapter bent with vent, Round bottom flask 100 ml	7100.00

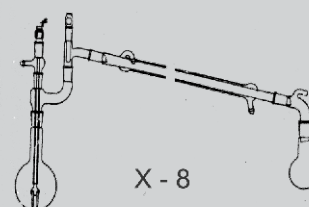

Assemblies
Reaction

Eswarr

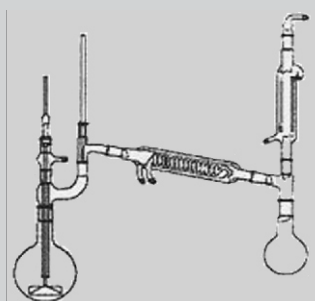

X - 9

X - 9 Reaction Assembly, *Eswarr*

Cat. No.	Components	Price
ES 1682	Round Bottom Flask 1000 ml, Multiple adapter two necks, Stirrer guide, Rubber sleeve gland, Collapsible paddle stirrer 450 mm, Still head Jacketed coil condenser 150 mm, Receiver adapter bent with socket connection, Round bottom flask 250 ml, Double surface condenser 200 mm, Cone adapter bent, Thermometer with P.T.F.E. cone	7205.00

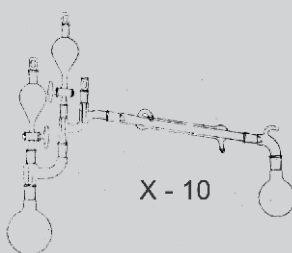

X - 10

X - 10 Reaction Assembly, *Eswarr*

Cat. No.	Components	Price
ES 1684	R.B. flask 500 ml, Multiple adapter two necks, Claisen head, Liebig condenser 200 mm, Receiver adapter bent with vent, R.B flask, 250 ml, Separating funnel, 100 ml x 2nos, Stopper 2Nos, Thermometer pocket	4950.00

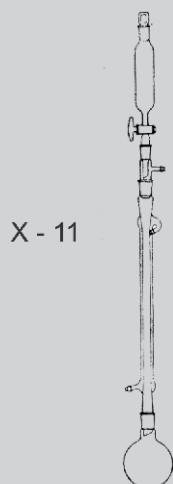

X - 11

X - 11 Reaction Assembly, *Eswarr*

Cat. No.	Components	Price
ES 1686	R.B. flask 500 ml, Liebig condenser 400 mm, Adapter with T connection, Separating funnel 100 ml, Stopper	2650.00

X - 12 Reaction Assembly, *Eswarr*

Cat. No.	Components	Price
ES 1687	R.B flask, 250 ml, Multiple Adapter, two necks, Still head Liebig condenser 200 mm, Receiver adapter, Thermometer pocket, Separating funnel, 100 ml, Stopper	2900.00

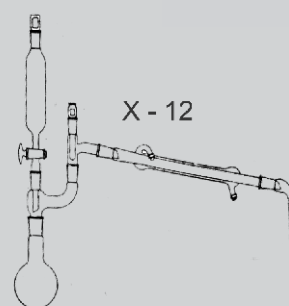

X - 13 Reaction Assembly, *Eswarr*

Cat. No.	Components	Price
ES 1688	R.B flask, 1000 ml, Multiple adapter, three necks, Stirrer guide, Stuffing box gland with pulley, Collapsible Paddle stirrer, 450 mm, Still head, Liebig Condenser 400 mm, Receiver adapter, bent with socket Connection R.B. Flask 500 ml, Drying tube, Thermometer pocket Separating funnel 100 ml, Stopper	8450.00

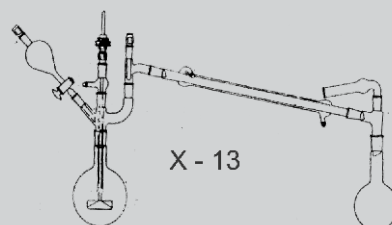

X - 14 Reaction Assembly, *Eswarr*

Cat. No.	Components	Price
ES 1690	R.B. Flask, 250 ml, Multiple adapter, two necks, Air leak tube, bent, Liebig condenser, 200 mm, Drying tube, Gas wash bottle body, 250 ml, Gas wash bottle fitting	2950.00

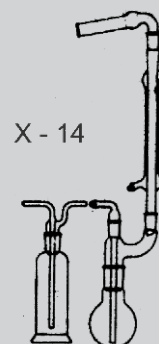

Assemblies
Distillation

Eswarr

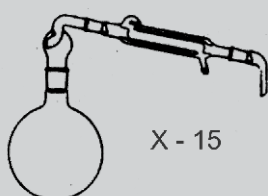

X - 15

X - 15 Distillation Assembly, *Eswarr*

Cat. No.	Components	Price
ES 1692	R.B flask, 2000 ml, Splash Head, Double surface condenser, 200 mm, Receiver adapter	2950.00

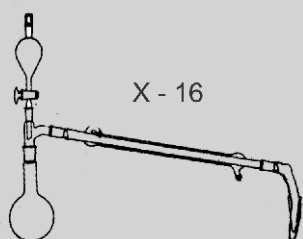

X - 16

X - 16 Distillation Assembly, *Eswarr*

Cat. No.	Components	Price
ES 1694	R.B flask 500 ml, Still head, Liebig condenser, 400 mm, Receiver adapter, Stopper Separating funnel 100 ml,	2750.00

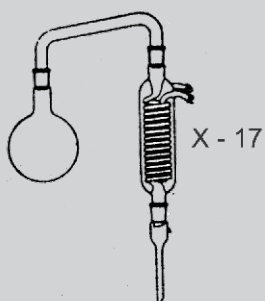

X - 17

X - 17 Distillation Assembly, *Eswarr*

Cat. No.	Components	Price
ES 1696	R.B flask, 250 ml, Recovery Bend, Thorpe condenser, 200 mm Receiver adapter	3950.00

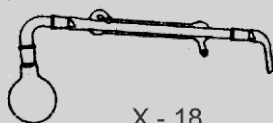

X - 18

X - 18 Distillation Assembly, *Eswarr*

Cat. No.	Components	Price
ES 1698	R.B flask, 250 ml, Recovery Bend, Liebig condenser, 200 mm Receiver adapter	1490.00

X - 19 Distillation Assembly, *Eswarr*

Cat. No.	Components	Price
ES 1700	R.B. flask, 3000 ml, Splash head adapter, Still head, Air condenser, 400 mm, Ether condenser, Receiver adapter Conical flask, 1000 ml, Stopper Thermometer with P.T.F.E. cone	11950.00

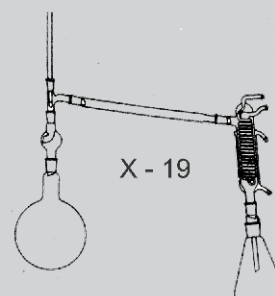
X - 20 Preparation Assembly, *Eswarr*

Cat. No.	Components	Price
ES 1702	R.B flask, 500 ml, Still head Thermometer with P.T.F.E. cone, Liebig condenser, 200 mm, Receiver adapter	2450.00

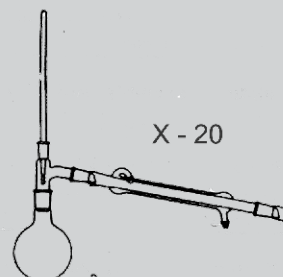

Assemblies
Vacuum Distillation

Eswarr

X - 21 Vacuum Distillation Assembly, *Eswarr*

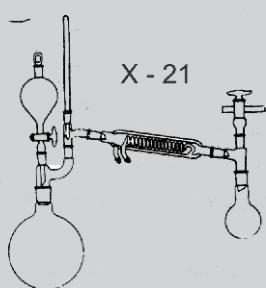

Cat. No.	Components	Price
ES 1704	R.B. flask, 3000 ml, Multiple adapter, two necks, Still head Jacketed coil condenser, 150 mm, Receiver adapter, bent with socket connection R.B. Flask, 250 ml, Vacuum release Stopcock, Thermometer with P.T.F.E. cone, Separating funnel 250 ml, Stopper	7950.00

X - 22 Vacuum Distillation Assembly, *Eswarr*

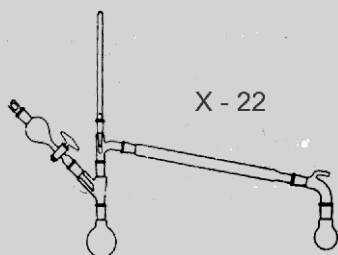

Cat. No.	Components	Price
ES 1706	R.B. flask, 100 ml, Multiple adapter, two necks, Still head Air condenser, 400 mm, Receiver adapter, bent with vent, R.B. flask, 50 ml, Thermometer with P.T.F.E. cone, Separating funnel, 50 ml, Stopper	4250.00

X - 23 Vacuum Distillation Assembly, *Eswarr*

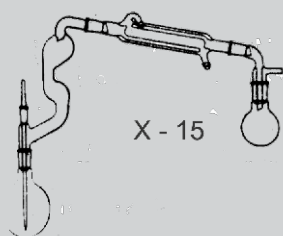

Cat. No.	Components	Price
ES 1708	R.B. flask, 500 ml, Splash head, double bulb, Double surface condenser, 200 mm Receiver adapter, with Vacuum connection, Round bottom flask, 100 ml, Air leak tube	4750.00

X - 24 Vacuum Distillation Assembly, *Eswarr*

Cat. No.	Components	Price
ES 1710	R.B. flask, 500 ml, Claisen head, Jacketed coil condenser, 150 mm, Receiver adapter with Vacuum connection, R.B. flask, 100 ml, Test tube 200 ml, Gas wash bottle fitting, Thermometer with P.T.F.E cone, Air leak tube	5250.00

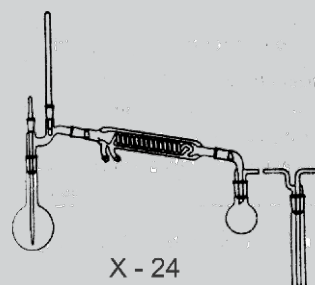

X - 24

X - 25 Vacuum Distillation Assembly, *Eswarr*

Cat. No.	Components	Price
ES 1712	R.B. flask, 1000 ml, Recovery bend, Double coil condenser Round bottom flask, two necks 500 ml, Vacuum release stopcock	5425.00

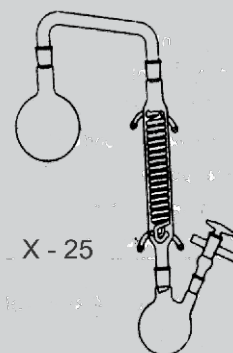

X - 25

X - 26 Vacuum Distillation Assembly, *Eswarr*

Cat. No.	Components	Price
ES 1714	R.B. flask, 1000 ml, Recovery bend, Jacketed coil condenser, 150 mm, Receiver adapter, bent With vent, R.B. flask, 250 ml	3950.00

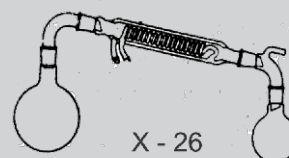

X - 26

Assemblies
Kjeldahl Distillation

Eswarr

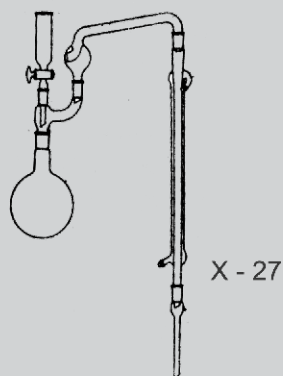

X - 27 Kjeldahl Distillation Assembly, *Eswarr*

Cat. No.	Description	Price
ES 1716	R.B. Flask, 1000 ml, Multiple adapter, two necks, Splash head, vertical, Liebig condenser, 400 mm, Receiver adapter, Separating funnel, 100 ml	3150.00

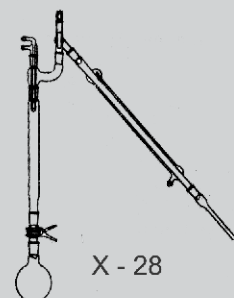

X - 28 Kjeldahl Distillation Assembly, *Eswarr*

Cat. No.	Components	Price
ES 1718	Kjeldahl flask, 800 ml, Multiple adapter, two necks, Splash head, vertical, Liebig condenser, 400 mm, Receiver adapter, Separating funnel, 100 ml	4650.00

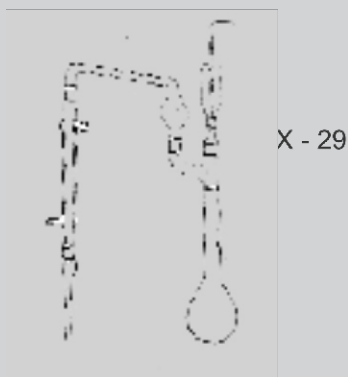

X - 29 Kjeldahl Distillation Assembly, *Eswarr*

Cat. No.	Components	Price
ES 1720	Kjeldahl flask 500 ml, Multiple adapter two necks, Dropping funnel 50 ml, Dropping funnel plug, Splash head, vertical Liebig condenser 200 mm Receiver adapter	3900.00
ES 1722	Kjeldahl flask 500 ml, Multiple adapter two necks, Dropping funnel 50 ml, Dropping funnel plug, Splash head, vertical Liebig condenser 200 mm Joint clip, S 19	4750.00

X - 30 Fractionation Assembly, *Eswarr*

Cat. No.	Components	Price
ES 1724	R.B. flask 500 ml, Cup Joint Adapter, Ball joint adapter Joint clip, S 35 Air condenser, 300 mm, Multiple adapter, two necks, Immersion condenser Still head, Thermometer pocket Receiver adapter, Plain bend Liebig condenser, 400 mm, Receiver adapter	5950.00

X - 31 Fractionation Assembly, *Eswarr*

Cat. No.	Components	Price
ES 1726	R.B. flask, 250 ml, Air condenser, 400 mm, Still head Thermometer with P.T.F.E. cone Liebig condenser, 200 mm Bend with multiple connection 3 x R.B. flask, 25 ml	4750.00

X - 32 Fractionation Assembly, *Eswarr*

Cat. No.	Components	Price
ES 1728	R.B. flask, 1000 ml, Swan neck adapter, Air condenser, 400 mm, Multiple adapter, two necks, Immersion condenser, Stillhead, Thermometer, with P.T.F.E. Cone, Liebig condenser, 400 mm, Ball joint adapter Cup joint adapter, Adapter with 'T' connection, Separating funnel, 100 ml, Reduction adapter R.B. Flask, two necks, 500 ml Vacuum release Stopcock, Joint clip, S 29	9350.00

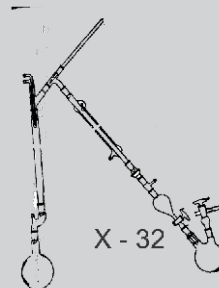
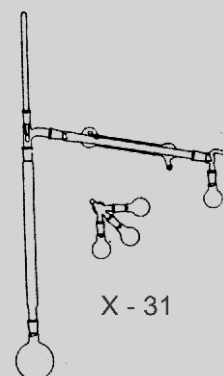

Gas Evaluation,
Steam Assembly

Eswarr



X - 34

X - 34 Gas Evolution Assembly, *Eswarr*

Cat. No.	Components	Price
ES 1730	Conical flask, 1000 ml, Adapter with 'T' connection, Separating funnel, 500 ml, Stopper	2950.00



X - 35

X - 35 Gas Evolution Assembly, *Eswarr*

Cat. No.	Components	Price
ES 1732	Buckner flask, 1000 ml, Thistle funnel head	1900.00



X - 36

X - 36 Gas Evolution Assembly, *Eswarr*

Cat. No.	Components	Price
ES 1734	Conical flask, 500 ml, Separating funnel, 100 ml	1850.00

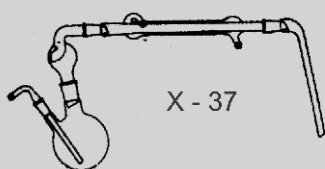

X - 37

X - 37 Steam Distillation Assembly, *Eswarr*

Cat. No.	Components	Price
ES 1736	RB. flask, two necks, 500 ml Splash head, Liebig condenser, 200 mm, Receiver adapter, Air leak tube	2350.00

Eswarr

Assemblies
Steam Distillation

X - 38 Steam Distillation Assembly, *Eswarr*

Cat. No.	Components	Price
ES 1738	R.B. flask, 500 ml, Still head Air leak tube, Liebig condenser 400 mm, Receiver adapter	2350.00

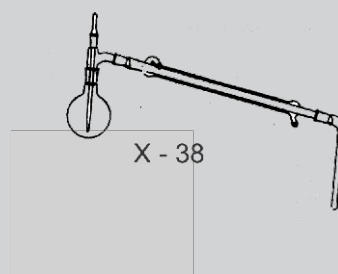

X - 39 Steam Distillation Assembly, *Eswarr*

Cat. No.	Components	Price
ES 1740	R.B. flask, 500 ml, Steam distillation head, Liebig condenser 400 mm, Receiver adapter	2790.00

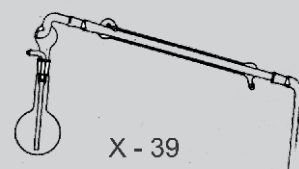

X - 40 Steam Distillation Assembly, *Eswarr*

Cat. No.	Components	Price
ES 1742	R.B. flask, 1000 ml, Multiple adapter, two necks, Air leak tube, bent, Recovery bend, Jacketed coil condenser, 150 mm Receiver adapter	3150.00

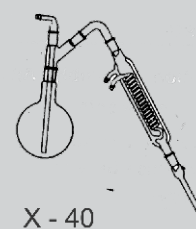

Assemblies
Misc. Distillation

Eswarr

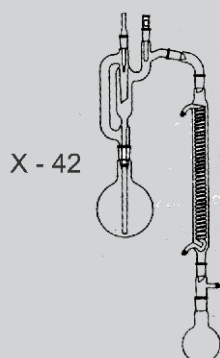

X - 42 Frothy Liquids Distillation Assembly, *Eswarr*

Cat. No.	Components	Price
ES 1744	R.B. flask, 1000 ml, Antifoaming splash head, Air leak tube, Thermometer pocket, Receiver adapter, Coil condenser, 300 mm, adapter with 'T' Connection R.B. flask, 250 ml	6150.00

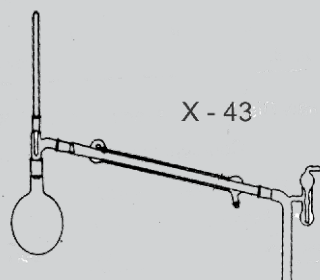

X - 43 Destructive Distillation Assembly, *Eswarr*

Cat. No.	Components	Price
ES 1746	R.B. flask, 1000 ml, Still head Thermometer with P.T.F.E. cone Liebig condenser, 400 mm, Gas absorption adapter with vacuum break	3700.00

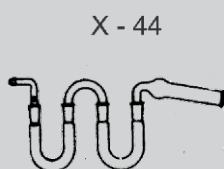

X - 44 Gas Absorption Assembly, *Eswarr*

Cat. No.	Components	Price
ES 1748	2 x U-tubes with socket 1 x U-tube with cone, Drying tube, Cone adapter, bent	1750.00

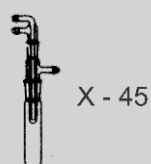

X - 45 Vacuum Sublimation Assembly, *Eswarr*

Cat. No.	Components	Price
ES 1750	Test tube, Adapter with 'T' connection, Immersion condenser	900.00

X - 46 Recovery Assembly, *Eswarr*

Cat. No.	Components	Price
ES 1752	R.B. flask, 250 ml, Multiple adapter, two necks, Recovery bend, Liebig condenser, 400 mm Receiver adapter, Separating funnel, 100 ml	2900.00

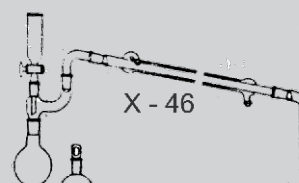

X - 47 Recovery Assembly, *Eswarr*

Cat. No.	Components	Price
ES 1754	R.B. flask, 2000 ml, Stillhead Jacketed coil condenser, 150 mm Receiver adapter, Separating funnel, 100 ml, Stopper	4450.00

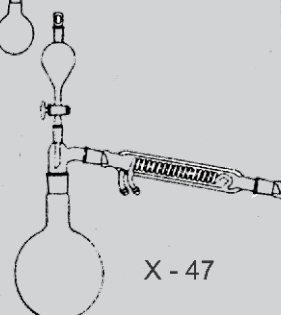

X - 48 Solvent Recovery Assembly, *Eswarr*

Cat. No.	Components	Price
ES 1756	F.B. flask, 150 ml, Recovery bend, Jacketed coil condenser 150 mm, Receiver adapter	3350.00

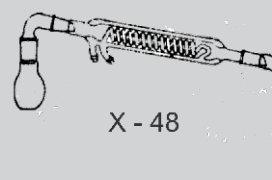

Assemblies
Solvent Recovery

Eswarr

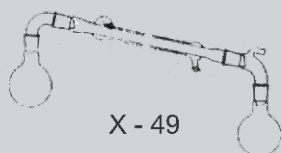

X - 49

X - 49 Solvent Recovery Assembly, *Eswarr*

Cat. No.	Components	Price
ES 1758	R.B. flask, 250 ml, Recovery Bend, Liebig condenser, 400 mm Receiver adapter bent with vent R.B. Flask, 250 ml	2150.00

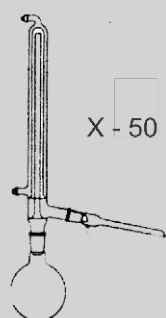

X - 50

X - 50 Solvent Recovery Assembly, *Eswarr*

Cat. No.	Components	Price
ES 1760	R.B. flask, 500 ml, Recovery bend, Air condenser, 200 mm Ether condenser, Buckner flask 250 ml	8150.00

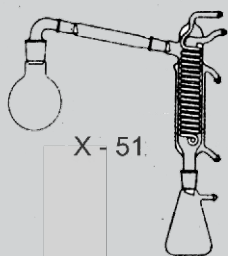

X - 51

X - 51 Solvent Recovery Assembly, *Eswarr*

Cat. No.	Components	Price
ES 1762	R.B. flask, 500 ml, Hopkins condenser, Receiver adapter	2150.00



X - 52

X - 52 Solvent Recovery Assembly, *Eswarr*

Cat. No.	Components	Price
ES 1764	F.B. flask, 250 ml, Plain body Extractor, Coil condenser, 150 mm	2750.00

X - 53 Distillation Unit Vacuum, *Eswarr*

Cat. No.	Components	Price
ES 1764	Reaction vessel, 20000 ml with 100 mm flat flange joint, 100 mm flat flange adapter with five necks Joining clip, 100 mm, Gas inlet Tube, Thermometer pocket, Stopper, Recovery bend, Thermometer with P.T.F.E. cone, Stirrer guide Ground sleeve gland, Anchor stirrer, 750 mm, Double coil condenser, 380 mm, Receiver adapter, Intermediate flask, 500 ml, Vacuum control stopcock Stopcock adapter, Round bottom Flask, two necks, 2000 ml Vacuum Release stopcock	69,000.00

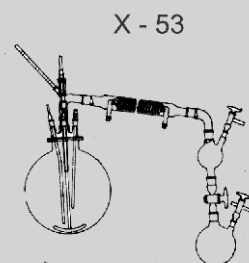

X - 54 Distillation Unit, *Eswarr*

Cat. No.	Components	Price
ES 1766	Reaction vessel, 10000 ml with 100 mm flat flange joint, 100 mm flat flange adapter with 4 necks Joining clip, 100 mm, Gas inlet tube, Stopper, Stirrer guide Ground sleeve gland, Anchor stirrer, 750 mm, Still head Double coil condenser, 230 mm, Receiver adapter, R.B.flask, 2000 ml Thermometer pocket	39,950.00

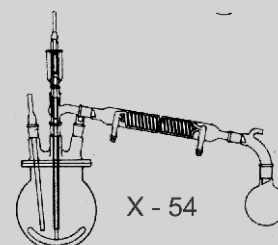

Determination
Alkoxy Group

Eswarr

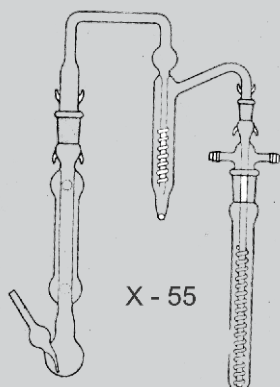

X - 55

X - 55 Alkoxy Group Determination Apparatus, *Eswarr*

Cat. No.	Components	Price
ES 1768	Distillation flask combines with condenser, Scrubber, Delivery tube with spiral, Receiver tube	3150.00

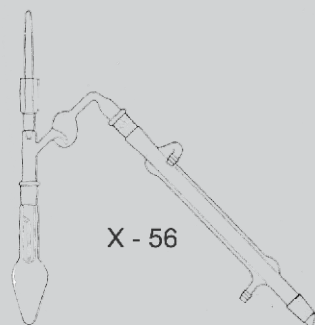

X - 56

X - 56 Acetyl Group Determination Apparatus, *Eswarr*

Cat. No.	Components	Price
ES 1770	Pear shape flask, 50 ml Still head, Liebig condenser 200 mm, Funnel plug (Reflux can be arranged by fitting the condenser directly into the flask)	1950.00

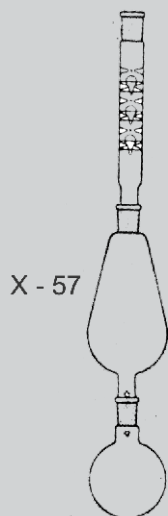

X - 57

X - 57 Kuderna Danish Evaporator, *Eswarr*

Cat. No.	Components	Price
ES 1772	R.B. flask 150 ml, Upper chamber 250 ml, Kuderna column	6250.00

X - 58 Climbing Film Evaporator, *Eswarr*

Cat. No.	Components	Price
ES 1774	Stopcock adapter, Reservoir 4000 ml, Flow indicator, Control stopcock, Evaporator tube, 1500 mm long, Joint clip S 29 Still head, Thermometer with PTFE cone, Cyclone body Jacketed coil condenser, 150 mm intermediate receiver flask 250 ml, 3 X vacuum control stopcock, Stopcock adapter, Receiver flask, two necks 1000 ml, 2 X vacuum release stopcock, Joint slip S 35 Still head, Double coil condenser 380 mm, Intermediate receiver flask 500 ml, Stopcock adapter Receiver flask, two necks, 2000 ml	52,950.00

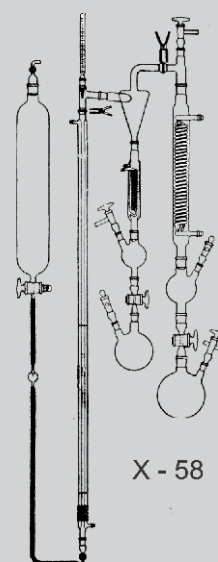

X - 59 Circulatory Cyclone Evaporator, *Eswarr*

Cat. No.	Components	Price
ES 1776	Steam heated cyclone evaporator Feed control stopcock, Still head Thermometer with PTFE cone Receiver adapter, Double Coil condenser 380 mm, Intermediate receiver flask 500 ml, vacuum control stopcock, Stopcock adapter Receiver flask, two necks, 2000 ml Vacuum release stopcock	36,950.00

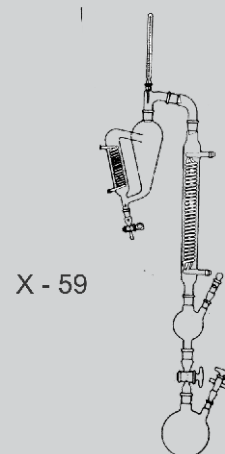

Dean &
Stark Apparatus

Eswarr

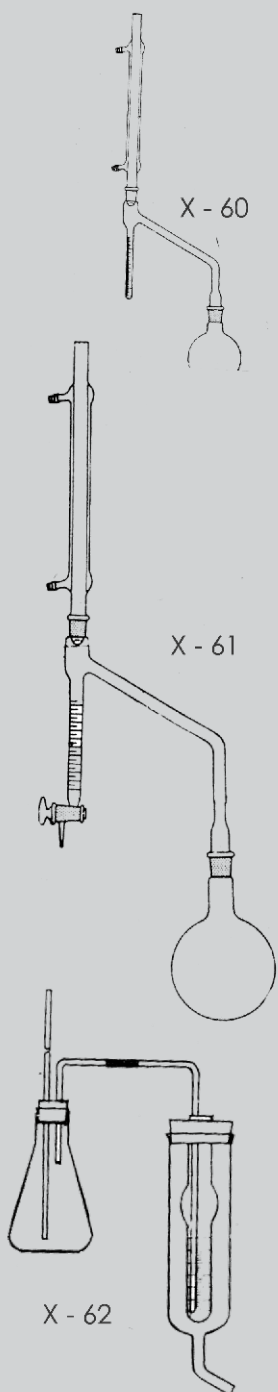

X - 60 Water Estimation Apparatus, (DEAN & STARK), Light Entrainer,
Without Stopcock, *Eswarr*

Cat. No.	Components	Price
ES 1778	Receiver 10 ml, R.B. Flask 1000 ml, Liebig condenser 400 mm	1850.00
ES 1780	Receiver 25 ml, R.B. Flask 1000 ml, Liebig condenser 400 mm	2150.00
ES 1782	Receiver 100 ml, R.B. Flask 1000 ml, Liebig condenser 400 mm	2650.00

X - 61 Water Estimation Apparatus, (DEAN & STARK), Light Entrainer,
Without Stopcock, *Eswarr*

Cat. No.	Components	Price
ES 1784	Receiver 10 ml, R.B. Flask 1000 ml, Liebig condenser 400 mm	2150.00
ES 1786	Receiver 25 ml, R.B. Flask 1000 ml, Liebig condenser 400 mm	2650.00
ES 1788	Receiver 100 ml, R.B. Flask 1000 ml, Liebig condenser 400 mm	3100.00

X - 62 Landsburger Boiling Apparatus (Walker Lumsden), *Eswarr*

Cat. No.	Description	Price
ES 1790	Comprising of graduated inner tube with outer Jacket and conical flask with connecting tubes Cork fitted	2100.00

Eswarr

Distillation Ammonia,
Mercury

X - 63 Re-Distillation Assembly, *Eswarr*

Cat. No.	Components	Price
ES 1792	F.B flask with a side tube 1000 ml, Coil condenser 200 mm, Stopper	2150.00

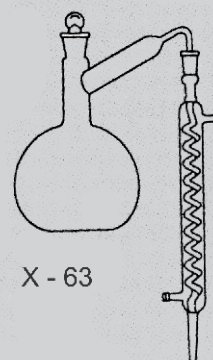

X - 63

X - 64 Ammonia Distillation Assembly, *Eswarr*

Cat. No.	Components	Price
ES 1794	Kjeldahl flask 800 ml Still head, Coil condenser 200 mm	2650.00

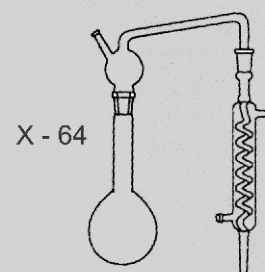

X - 64

X - 65 Mercury Distillation Assembly, Hulett, *Eswarr*

Cat. No.	Components	Price
ES 1796	Distilling flask 500 ml Stopcock controlled air bleeding tube, Air condenser 500 mm, Liebig condenser 200 mm, Receiver adapter, with vacuum, Connection Receiving bottle 500 ml	3650.00

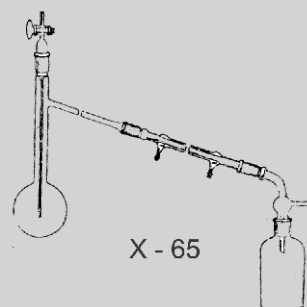

X - 65

Membrane Filter,
Markham Distillation

Eswarr

X - 66

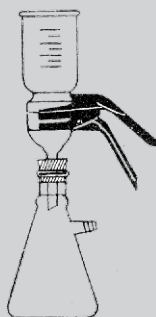

X - 66 Membrane Filter Holder Assembly, with Rubber Cork, *Eswarr*

Cat. No.	Components	Price
ES 1798	Funnel for 13 & 25 size filter Base with sintered disc for 13 size filter Spring Clamp, 13 & 25 size 100 ml Buchner Flask with cork	4650.00
ES 1800	Funnel for 13 & 25 size filter Base with sintered disc for 25 size filter Spring Clamp, 13 & 25 size 100 ml Buchner Flask with cork	4950.00

X - 67 Markham Semi-Micro Distillation Unit, *Eswarr*

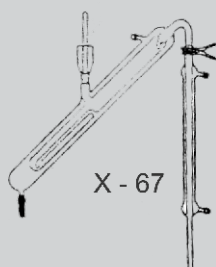

X - 67

Cat. No.	Components	Price
ES 1802	Markham still body, Funnel plug, Liebig condenser 200 mm, Joint clip, S 19	6900.00
ES 1804	Markham still body, Funnel plug, Liebig condenser 200 mm, Receiver adapter	6250.00

X - 68 Parnas & Wagner Apparatus (Standard Type), *Eswarr*

Cat. No.	Components	Price
ES 1806	Steam generating flask, 1000 ml, Steam trap, Vacuum jacketed flask, Funnel with pinch cock, Condenser body condenser inner tube (glass) Receiving flask 250 ml, Stand, clamps and burner as suggested B.S.S.	9950.00
ES 1808	Steam generating flask, 1000 ml, Steam trap, Vacuum jacketed flask, Funnel with pinch Cock, Condenser Body Condenser inner tube (silver) Receiving Flask 250 ml, Stand, clamps and burner as suggested in B.S.S.	14,650.00

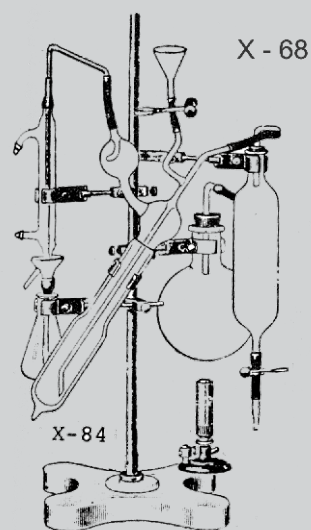

X - 69 Vacuum Jacketed, flask for Parnas Wagner Apparatus, *Eswarr*

Cat. No.	Components	Price
ES 1810	Flask for rubber tube connection	2900.00

X - 70 Flask, Dewar, Silvered without carrying case and stopper, *Eswarr*

Cat. No.	Cap. MI	Price
ES 1812	250	1650.00
ES 1814	500	2350.00
ES 1816	1000	4625.00
ES 1818	1500	9325.00
ES 1820	2000	12,650.00

Determination
Essential Oil Etc.

Eswarr

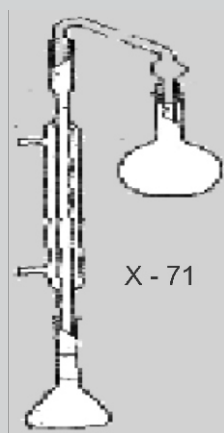

X - 71 Volatile Acid Determination Apparatus, *Eswarr*

Cat. No.	Description	Price
ES 1822	Polenske and Reichertmeissl For the determination of soluble and insoluble volatile acids in fats and oils. For analysis of butter and butter fats. Comprising of 300 ml flask, still head, condenser and receiver flask graduated at 100 and 110 ml.	1435.00
ES 1824	Comprising of the parts of 2178 but complete with stand, clamps and burner	2950.00

X - 72 Essential Oil Determination Apparatus, *Eswarr*

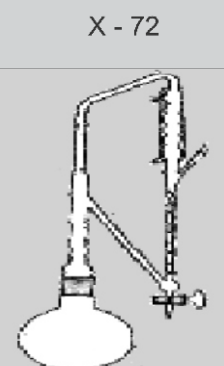

Cat. No.	Description	Price
ES 1826	Cocking and middleton - For the determination of volatile oil in drugs comprising of 1000 ml flask and vertical tube combined with condenser and measuring tube with stopcock. A return tube For the aqueous part of the distillate connects the bottom of the measuring tube and the vertical tube	4950.00

Eswarr

Determination
Essential Oil Etc.

X - 73 Essential Oil Determination Apparatus, *Eswarr*

Cat. No.	Description	Price
ES 1828	Clevenger - For the determination of volatile oil lighter than water Comprising of 1000 ml flask, oil separator tube and condenser	3950.00

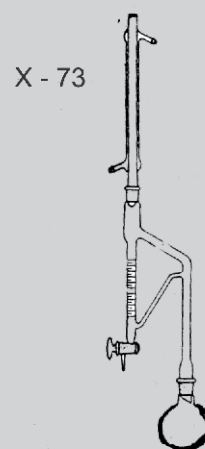

X - 74 Essential Oil Determination Apparatus, *Eswarr*

Cat. No.	Description	Price
ES 1830	Clevenger - For the determination of volatile oil Higher than water Comprising of 1000 ml flask, oil separator tube and condenser	3950.00

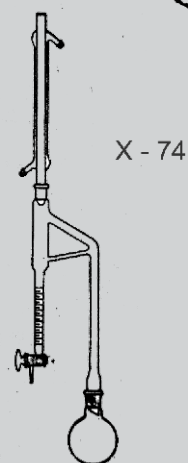

Extraction
Soxhlet

Eswarr

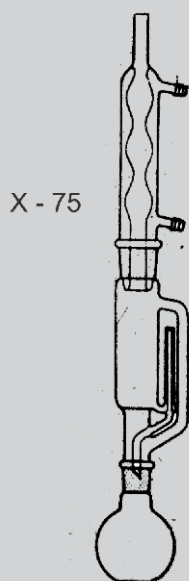

X - 75

X - 75 Soxhlet Extraction Apparatus, *Eswarr*

Cat. No.	Components	Price
ES 1832	Extractor 40 ml, F.B. flask 100 ml, Allihn condenser 200 mm	1390.00
ES 1834	Extractor 60 ml, F.B. flask 150 ml, Allihn condenser 200 mm	1390.00
ES 1836	Extractor 100 ml, (34/35 socket) F.B. flask 250 ml, Allihn condenser 200 mm (34/35 cone)	1510.00
ES 1838	Extractor 100 ml, (40/38 socket) F.B. flask 250 ml, Allihn condenser 200 mm (40/38 cone)	1550.00
ES 1840	Extractor 200 ml, F.B. flask 500 ml, Allihn condenser 200 mm	2450.00

X - 76 Extractor Only for Soxhlet Apparatus, *Eswarr*

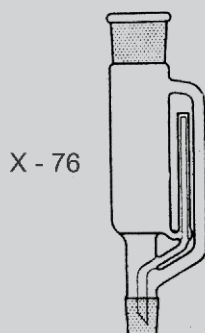

X - 76

Cat. No.	Cap. MI	Socket	Cone	Price
ES 1842	60	34/35	24/29	610.00
ES 1844	100	34/35	24/29	610.00
ES 1846	100	40/38	24/29	930.00
ES 1848	200	50/42	24/29	990.00
ES 1850	250	50/42	24/29	990.00

Eswarr

Gas Analysis
Orsat 3-test

X - 77 Gas Analysis Apparatus, 3 Test, Orsat, *Eswarr*

Cat. No.	Description	Price
ES 1852	For the analysis of CO ₂ , CO and O ₂ Comprising of levelling bottle, 100 ml gas burette with outer Jacket, three absorption pipettes (two filled with glass tubes and one with copper spiral and glass Tubes), 3-test manifold, calcium Chloride tube and rubber bellow. In woodencase with sliding doors.	9900.00

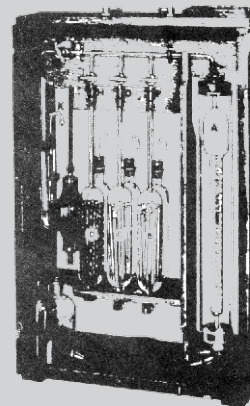

X - 77

SPARES : *Eswarr*

Cat. No.	Description	Price
ES 1854	100 ml gas burette with outer jacket for 2210	1650.00
ES 1856	3 test manifold for 2210	2150.00
ES 1858	Absorption pipette filled with glass tubes for 2210	990.00

Gas Analysis
4-test

Eswarr

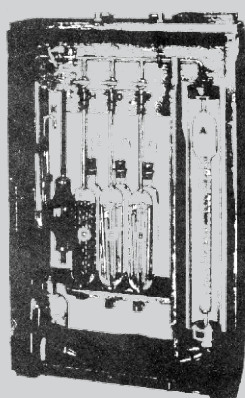

X - 78

X - 78 Gas Analysis Apparatus, 4 Test, Orsat, *Eswarr*

Cat. No.	Description	Price
ES 1860	Similar to 2210 in general design but with four pipettes and a palladium asbestos tube. This is for the analysis of CO ₂ , CO, O ₂ , H ₂ , and nitrogen (by difference). Comprising Of levelling bottle, 100 ml, gas burette with outer jacket four Absorption pipettes (Two filled with glass tubes, one filled with copper spiral and glass tubes and the other Plain). Palladium asbestos tube, adjustable spirit lamp, 4-test manifold, calcium chloride tube and rubber bellow. In wooden case with sliding doors.	14750.00

SPARES : *Eswarr*

Cat. No.	Description	Price
ES 1862	100 ml gas burette with outer jacket for 2214	1490.00
ES 1864	4 test manifold for 2214	2650.00
ES 1866	Absorption pipette filled with glass tubes for 2214	990.00
ES 1868	Palladium asbestos tube for 2214	850.00

X - 79 Gas Burettes, Tutweiler, *Eswarr*

Cat. No.	Description	Price
ES 1870	For determining hydrogen sulphide in illuminating and other gases. The burette has two stopcocks at top and bottom and is graduated at 100 ml and 110 ml. The volume between the 110 ml Mark and the lower stopcock is Approximately 5 ml. The 10 ml reservoir is graduated in 0.1 ml Divisions.	2450.00
ES 1872	Similar to 2223 but with graduations at 500 ml, 520 ml and 540 ml. The volume between 540 ml mark and the lower stopcock is approximately 25 ml	3900.00

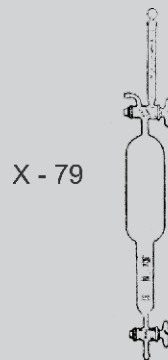

X - 80 Gas Burettes, Bunte, *Eswarr*

Cat. No.	Description	Price
ES 1874	This burette has two stopcocks and stoppered cup. The bulb Capacity is 55 ml and the burette is graduated 45-0-15 ml in 0.2 ml Divisions. The stoppered cup is graduated at 20 ml and 25 ml.	2650.00

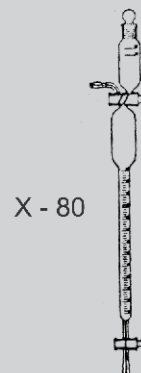

X - 81 Gas Sampling Tubes, Straight Bore Stopcock, *Eswarr*

Cat. No.	Cap. Ml	Price
ES 1876	125	860.00
ES 1878	250	1060.00
ES 1880	500	1490.00
ES 1882	1000	2950.00

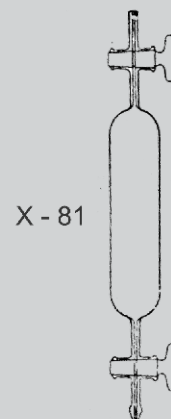

Water Still
Single Distillation

Eswarr

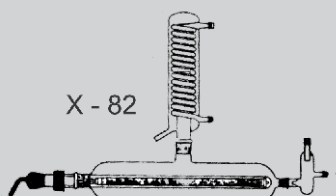

X - 82

X - 82 Water Still Single Distillation, *Eswarr*

Cat. No.	Description	Price
ES 1884	Single distillation water still All glass construction with Quartz sheathed 1 K.W. heater fitted by PTFE sleeve - Completely interchangeable parts - Capable of producing high quality water with an output of 1.0 to 1.2 Liters per hour complete with stand	15,600.00

X - 83 Water Still Single Distillation, *Eswarr*

Cat. No.	Description	Price
ES 1886	Single distillation water still All glass construction with Quartz sheathed 1 K.W. heater fitted by PTFE sleeve - Completely interchangeable parts - Capable of producing high quality water with an output of 2.0 to 2.2 Liters per hour complete with stand	24,600.00

SPARES : *Eswarr*

Cat. No.	Description	Price
ES 1888	Boiling chamber with B 34, B 29 & B 19 sockets	3900.00
ES 1890	Condenser with B 34 cone	3900.00
ES 1892	Constant level device with B 19 cone	390.00
ES 1894	Quartz sheathed heater with PTFE B 29 cone	9400.00
ES 1896	Stand	2650.00

X - 84 Water Still Double Distillation, *Eswarr*

Cat. No.	Description	Price
ES 1898	Double distillation water still All glass construction with two Quartz sheathed 1 K.W. heater fitted by PTFE sleeve - Completely inter-changeable parts - Capable of producing extremely pure water with an output of 1.0 to 1.2 liters per hour. complete with stand	27600.00

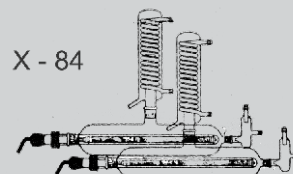

X - 85 Water Still Double Distillation, *Eswarr*

Cat. No.	Description	Price
ES 1900	Double distillation water still All glass construction with two Quartz sheathed 1 K.W. heater fitted by PTFE sleeve - Completely inter-changeable parts - Capable of producing extremely pure water with an output of 2.0 to 2.2 liters per hour. complete with stand	49500.00

SPARES : *Eswarr*

Cat. No.	Description	Price
ES 1902	Boiling chamber with B 34, B 29 & B 19 sockets	3900.00
ES 1904	Condenser with B 34 cone	3900.00
ES 1906	Constant level device with B 19 cone	390.00
ES 1908	Quartz sheathed heater with PTFE B 29 cone	9400.00
ES 1910	Stand	2650.00

NABL CERTIFIED
ISO CALIBRATION 4787

Eswarr

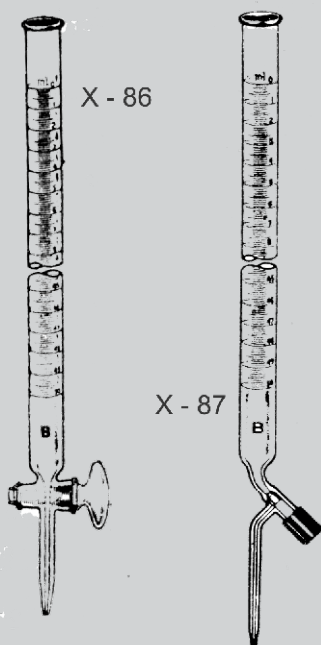

X - 86 Burette with Teflon or Glass Stopcock Class A, *Eswarr*

Cat. No.	Cap.	Tol.	Div.	Price
ES 1912	10	0.03	0.05	925.00
ES 1914	25	0.05	0.1	980.00
ES 1916	50	0.05	0.1	1150.00

X - 87 Burette AMBER with Teflon or Glass Stopcock Class A, *Eswarr*

Cat. No.	Cap.	Tol.	Sub Div.	Price
ES 1918	10	0.03	0.05	1950.00
ES 1920	25	0.05	0.1	1950.00
ES 1922	50	0.05	0.1	1950.00

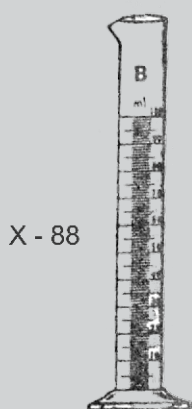

X- 88 Measuring Cylinders, with Spout, Class A, *Eswarr*

Cat. No.	Cap.	Sub Div.	Price
ES 1924	5	0.1	350.00
ES 1926	10	0.2	380.00
ES 1928	25	0.5	420.00
ES 1930	50	1	505.00
ES 1932	100	1	590.00
ES 1934	250	2	910.00
ES 1936	500	5	1410.00
ES 1938	1000	10	1570.00

Eswarr

NABL CERTIFIED
ISO CALIBRATION 4787

X - 89 Measuring (Graduated) Pipettes. Class A, (MOHR TYPE) *Eswarr*

Cat. No.	Cap.	Sub Div.	Tole. ml	Price
ES 1940	1	0.01	0.007	340.00
ES 1942	2	0.02	0.010	340.00
ES 1944	5	0.05	0.030	410.00
ES 1946	10	0.1	0.050	410.00
ES 1948	20	0.1	0.100	460.00
ES 1950	25	0.1	0.100	510.00

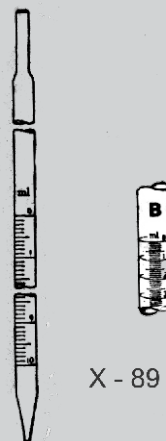

X - 89

X - 90 Volumetric Pipettes, One Mark, Class A, *Eswarr*

Cat. No.	Cap.	Tole. ml	Price
ES 1952	1	0.008	225.00
ES 1954	2	0.010	225.00
ES 1956	5	0.015	245.00
ES 1958	10	0.020	310.00
ES 1960	20	0.030	290.00
ES 1962	25	0.030	410.00



X - 90

X - 91 Volumetric (Standard) Flask with Stopper, Class A, *Eswarr*

Cat. No.	Cap.	Tol. ml	Price
ES 1964	5	0.025	480.00
ES 3452	10	0.025	490.00
ES 3453	25	0.040	490.00
ES 3454	50	0.060	580.00
ES 3455	100	0.100	580.00
ES 3456	200	0.150	610.00
ES 3457	250	0.150	710.00
ES 3458	500	0.250	950.00
ES 3459	1000	0.400	1310.00
ES 3460	2000	0.600	4680.00
ES 1984	5000	1.200	11820.00

X - 91, 92

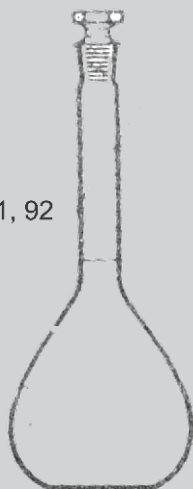

X - 92 Volumetric (Standard) Flask Amber with Stopper, Class A, *Eswarr*

Cat. No.	Cap.	Tol. ml	Price
ES 1986	5	0.025	950.00
ES 1988	10	0.025	950.00
ES 1990	25	0.040	950.00
ES 1992	50	0.060	890.00
ES 1994	100	0.100	890.00
ES 1996	200	0.150	990.00
ES 1998	250	0.150	1090.00
ES 2000	500	0.250	1290.00
ES 2002	1000	0.400	2076.00
ES 2004	2000	0.600	6120.00
ES 2006	5000	1.200	17340.00

1. Creating strong provocative relationships between good companies and their customers.
2. There is no sore, it will not heal, no customers it will not subdue.
3. Customer service is just a day in, day out ongoing, never ending, unremitting, persevering, compassionate, type of activity
4. Customer service is not a department, It's everyone's job.
5. If you like a lot of glassware, chemicals and instruments on your basic join our club
6. Get more from life with *Eswarr* scientific & co.
7. *Eswarr* Scientific & Co for better future.
8. It's fast, it's furious, it's *Eswarr* scientific & co.
9. Quality never goes out of style.
10. The customer is always and completely right.
11. Solutions for a small planet.
12. The goal as a company is to have customer service that is not just the best but legendary .

